



# Indice

Tabella applicazioni commutatori bloccasterzo e kit serrature .....	3
<i>APRILIA SCOOTER</i> .....	3
<i>APRILIA MOTO</i> .....	4
<i>BENELLI</i> .....	5
<i>BETAMOTOR</i> .....	5
<i>DERBI</i> .....	5
<i>GILERA</i> .....	6
<i>HONDA</i> .....	6
<i>KYMCO</i> .....	6
<i>ITALJET</i> .....	7
<i>MALAGUTI</i> .....	7
<i>MBK</i> .....	8
<i>PEUGEOT</i> .....	9
<i>PIAGGIO</i> .....	9
<i>SUZUKI</i> .....	10
<i>YAMAHA</i> .....	10
Commutatori bloccasterzo di primo equipaggiamento e adattabili .....	11
<i>APRILIA</i> .....	11
<i>BENELLI</i> .....	12
<i>DERBI/PIAGGIO</i> .....	12
<i>HONDA</i> .....	12
<i>KYMCO</i> .....	13
<i>ITALJET</i> .....	14
<i>MALAGUTI</i> .....	14
<i>MBK/YAMAHA</i> .....	14
<i>PEUGEOT</i> .....	15
<i>SUZUKI</i> .....	15
Kit serrature di primo equipaggiamento e adattabili .....	16
<i>APRILIA</i> .....	16
<i>BENELLI</i> .....	19
<i>BETAMOTOR</i> .....	19
<i>DERBI/GILERA/PIAGGIO</i> .....	19
<i>HONDA</i> .....	20
<i>KYMCO</i> .....	22
<i>ITALJET</i> .....	23
<i>MALAGUTI</i> .....	23
<i>MBK/YAMAHA</i> .....	23
<i>PEUGEOT</i> .....	25
<i>SUZUKI</i> .....	25
Tabella applicazioni serrature Derbi/Gilera/Piaggio .....	26
<i>DERBI SCOOTER</i> .....	26
<i>GILERA</i> .....	26
<i>PIAGGIO SCOOTER</i> .....	26
<i>PIAGGIO CICLOMOTORI</i> .....	28
<i>PIAGGIO VESPA - COSA</i> .....	28
<i>PIAGGIO APE</i> .....	31
Serrature di primo equipaggiamento Derbi/Gilera/Piaggio .....	32
Serrature bloccasterzo moto e ciclomotori vari .....	36
Blocchetti avviamento con chiave .....	36
Quadretti avviamento Piaggio .....	37
Tabella applicazioni commutatori luci e frecce Piaggio Vespa - Ape .....	38
<i>VESPA</i> .....	38
<i>VESPA PX</i> .....	39
<i>VESPA PK</i> .....	40
<i>APE</i> .....	41
Commutatori luci e frecce Piaggio Vespa-Ape .....	42
Commutatori e pulsanti vari per ciclomotori e moto .....	45
Tabella orientativa applicazioni claxon e trombe .....	47
<i>APRILIA</i> .....	47
<i>BENELLI</i> .....	47
<i>CAGIVA</i> .....	47
<i>DERBI</i> .....	48
<i>DUCATI</i> .....	48
<i>GILERA</i> .....	48
<i>HONDA</i> .....	49
<i>KAWASAKI</i> .....	49
<i>KYMCO</i> .....	50
<i>LAVERDA</i> .....	50
<i>MALAGUTI</i> .....	50
<i>MBK</i> .....	51
<i>MOTO GUZZI</i> .....	51
<i>MOTO MORINI</i> .....	51
<i>PEUGEOT</i> .....	52
<i>PIAGGIO CICLOMOTORI-SCOOTER</i> .....	52
<i>PIAGGIO VESPA-APE</i> .....	52
<i>SUZUKI</i> .....	53
<i>YAMAHA</i> .....	53
Claxon corrente alternata .....	54
Claxon e trombe corrente continua .....	55
Segnalatori acustici .....	58
Intermittenze .....	59
Interruttori stop .....	64
Interruttori idraulici stop .....	68
Bulbi pressione olio .....	68
Attacchi candela .....	68
Gruppi cavi impianti elettrici completi "Piaggio Vespa" .....	71
<i>VESPA</i> .....	71
<i>VESPA PX</i> .....	72
Resistenze .....	73
Prese di corrente .....	73
Cavi e cavetti .....	73
Connettori .....	73
Capocorda .....	74
Fusibili in vetro .....	75
Fusibili normali .....	75
Fusibili a lama - tipo normale "Fuse Blade" .....	75
Fusibili a lama - tipo piccolo "Mini Blade" .....	76
Spie luci .....	76
Articoli vari .....	76
Pompe "Mitsuba" .....	76

## Tabella applicazioni commutatori bloccasterzo e kit serrature

Marca, c.c., modello, anno	Commutatore bloccasterzo	Riferimento originale	Fig. pag.	Kit serrature completo	Riferimento originale	Fig. pag.
<b>APRILIA SCOOTER</b>						
50 Amico/LK/LX/Sport/GL (91/98)	09.2336 **□	AP8212336	11			
50 Gulliver Air/LC (94/>)	09.72337 ●		11	09.71732 ●	AP8201732	17
50 Habana/Habana Custom (99/03)				09.71850 ●	AP8202149	17
50 Mojito Retrò/Custom (99/03)				09.71850 ●	AP8202149	17
50 Mojito Custom 2T (04/08)				09.71852 ●	AP8104050	17
50 Rally Air/LC (95/00)	09.72337 ●	AP8201600	11	09.1492 **□ 09.71492 ●	AP8201845	16 16
50 Scarabeo/Street 2T (Mot. Minarelli - 93/06)	09.71793 ●	AP8201793	11	09.1590 □ 09.71590 ●	AP8201846	16 16
50 Scarabeo Street 2T/Rst (Mot. Piaggio - 05/09)	09.71793 ●	AP8224524	11	09.1590 □ 09.71590 ●	AP8201846	16 16
50 Scarabeo 2T/Net (Mot. Piaggio - 09/11)	09.74010 ●	AP8104599/860579	12			
50 Scarabeo Di-Tech (01/07)				09.2346 **□	AP8202350	16
50 Scarabeo 4 Tempi/Rst Euro 3 (02/09)	09.74010 ●	AP8104599/860579	12	09.2612 □ 09.72612 ●	AP8202329/85180R	16 16
50 Scarabeo Quattro/4V-4T/4T Net (09/11)	09.74010 ●	AP8104599/860579	12	09.2612 □ 09.72612 ●	85180R	16 16
50 Sonic/LC/GP (98/08)				09.72014 ●	AP8202014	18
50 SR Air UrbanKid/Viper/Replica/Europe (93/96)	09.72337 ●	AP8201600	11	09.1492 **□ 09.71492 ●	AP8201845	16 16
50 SR Air Esquire/Wave/UrbanKid/Sunfire (94/96)	09.72337 ●	AP8201600	11	09.1492 **□ 09.71492 ●	AP8201845	16 16
50 SR LC/Replica (94/96)	09.72337 ●	AP8201600	11	09.1492 **□ 09.71492 ●	AP8201845	16 16
50 SR Air WWW (97/02)	09.72337 ●	AP8201600	11	09.1492 **□ 09.71492 ●	AP8201845	16 16
50 SR H <sub>2</sub> O Stealth/Netscaper (Mot. Minarelli - 97/00)	09.72337 ●	AP8201600	11	09.1492 **□ 09.71492 ●	AP8201845	16 16
50 SR H <sub>2</sub> O Racing (Mot. Minarelli - 97/00)	09.72337 ●	AP8201600	11	09.1492 **□ 09.71492 ●	AP8201845	16 16
50 SR H <sub>2</sub> O Racing/Sport (Mot. Aprilia carb. - 00/04)	09.2345 **□ 09.72345 ●	AP8224343	11 11	09.72344 ●	AP8202386	18
50 SR Di-Tech/E2 (Mot. Aprilia Di-Tech - 00/04)	09.2345 **□ 09.72345 ●	AP8224343	11 11	09.72344 ●	AP8202386	18
50 SR New Di-Tech (Mot. Aprilia Di-Tech - 04/06)				09.74003 ●	AP8202396/859841	18
50 SR R Factory IE (Mot. Aprilia Di-Tech - 04/06)				09.74003 ●	AP8202396/859841	18
50 SR R Factory IE/SBK (Mot. Piaggio Iniez. - 04/11)				09.74003 ●	AP8202396/859841	18
50 SR Street IE (Mot. Piaggio Iniez. - 03/11)	09.2345 **□ 09.72345 ●	AP8224343	11 11	09.72344 ●	AP8202386	18
100 Scarabeo 4 Tempi/Rst Euro 3/Net (01/11)	09.74010 ●	AP8104599/860579	12	09.2612 □ 09.72612 ●	AP8202329/85180R	16 16
125 Atlantic/Euro 3 (03/11)				09.72611 ●	AP8104418	18
125 Habana/Habana Custom (99/03)				09.71852 ●	AP8104050	17
125 Mojito Retrò/Custom (99/03)				09.71852 ●	AP8104050	17
125/150 Mojito/Custom (03/07)				09.71850 ●	AP8202149	17
125 Mojito Euro 3 (08/10)				09.71850 ●	AP8202149	17
125/150 Leonardo (96/98)				09.71070 ●	AP8102412	16
125/150 Leonardo/ST (99/04)	09.74008 ●	AP8102924	12	09.71840 ●	AP8102923	17
125/150 SR (99/01)				09.71851 ●	AP8102975	17
125/150 Scarabeo (99/04 - Mot. Rotax)				09.71842 ●	AP8102841	17
125 Scarabeo Euro 2 (03 - Mot. Piaggio)				09.71842 ●	AP8102841	17
125 Scarabeo Euro 2 (04/06 - Mot. Piaggio)				09.74004 ●	AP8104824	18

□ Di primo equipaggiamento

● Adattabile

\*\* Ad esaurimento scorte

**4** Tabella applicazioni commutatori bloccasterzo e kit serrature Aprilia scooter • Aprilia moto

Marca, c.c., modello, anno	Commutatore bloccasterzo	Riferimento originale	Fig. pag.	Kit serrature completo	Riferimento originale	Fig. pag.
125 Scarabeo Euro 3 (06/07)				<b>09.74009 ●</b>	852139	19
125 Sport City/Euro 3 (04/08)	<b>09.2641 □</b>	AP8590049	11	<b>09.2640 **□</b> <b>09.72640 ●</b>	AP8104726/85181R	16 16
125 Sport City Cube (08/11)	<b>09.2641 □</b>	AP8590049	11	<b>09.2640 **□</b> <b>09.72640 ●</b>	AP8104726/85181R	16 16
200 Atlantic (03/05)				<b>09.72611 ●</b>	AP8104418	18
200 Scarabeo (01/04 - Mot. Rotax)				<b>09.71842 ●</b>	AP8102841	17
200 Scarabeo Euro 2 (03 - Mot. Piaggio)				<b>09.71842 ●</b>	AP8102841	17
200 Scarabeo Euro 3 (06/07 - Mot. Piaggio)				<b>09.74009 ●</b>	852139	19
200 Sport City/Euro 3 (04/08)	<b>09.2641 □</b>	AP8590049	11	<b>09.2640 **□</b> <b>09.72640 ●</b>	AP8104726/85181R	16 16
200 Sport City Cube (08/11)	<b>09.2641 □</b>	AP8590049	11	<b>09.2640 **□</b> <b>09.72640 ●</b>	AP8104726/85181R	16 16
250 Atlantic/Euro 3 (03/09)				<b>09.72611 ●</b>	AP8104418	18
250 Scarabeo Euro 2 (04/06)				<b>09.74004 ●</b>	AP8104824	18
250 Sport City (06/08)	<b>09.2641 □</b>	AP8590049	11	<b>09.2640 **□</b> <b>09.72640 ●</b>	AP8104726/85181R	16 16
250 Sport City Cube (08/11)	<b>09.2641 □</b>	AP8590049	11	<b>09.2640 **□</b> <b>09.72640 ●</b>	AP8104726/85181R	16 16
250 Leonardo/ST (99/04)	<b>09.74008 ●</b>	AP8102924	12	<b>09.71843 ●</b>	AP8102877	17
300 Atlantic (10/11)				<b>09.72611 ●</b>	AP8104418	18
300 Leonardo (04/05)	<b>09.74008 ●</b>	AP8102924	12	<b>09.71843 ●</b>	AP8102877	17
300 Sport City Cube (08/11)	<b>09.2641 □</b>	AP8590049	11	<b>09.2640 **□</b> <b>09.72640 ●</b>	AP8104726/85181R	16 16
400 Atlantic Sprint (05/10)				<b>09.72611 ●</b>	AP8104418	18
500 Atlantic Sprint (05/10)				<b>09.72611 ●</b>	AP8104418	18

## APRILIA MOTO

50 AF1 Futura (90/92) • 50 AF1 Replica (91/92)	<b>09.2342 **□</b> <b>09.72342 ●</b>	AP8212342	11 11			
50 AF1 Europa (90)	<b>09.72710 ●</b>	AP8112710	11			
50 AF1 Europa (91/92)	<b>09.2342 **□</b> <b>09.72342 ●</b>	AP8212342	11 11			
50 Pegaso (91/94)	<b>09.2342 **□</b> <b>09.72342 ●</b>	AP8212342	11 11			
50 MX Motard (02/03)	<b>09.72710 ●</b>	AP8112710	11			
50 Red Rose (89/92)	<b>09.72710 ●</b>	AP8112710	11			
50 RS/Extrema (93/97)	<b>09.2342 **□</b> <b>09.72342 ●</b>	AP8212342	11 11			
50 RS (98)	<b>09.72710 ●</b>	AP8112710	11			
50 RS (99/05)				<b>09.1602 **□</b> <b>09.71602 ●</b>	AP8202358	16 16
50 RS (06/10)				<b>09.74006 ●</b>	861029/86151R	18
50 RS Tuono (03/05)				<b>09.1602 **□</b> <b>09.71602 ●</b>	AP8202358	16 16
50 RX 3/5 Marce (90/97)	<b>09.2342 **□</b> <b>09.72342 ●</b>	AP8212342	11 11			
50 RX Enduro (98/03 - MU00/ST00)	<b>09.72710 ●</b>	AP8112710	11			
50 RX (06/11)				<b>09.74005 ●</b>	861013	18
50 SX (06/11)				<b>09.74005 ●</b>	861013	18
125 AF1 Europa (90/91)	<b>09.72710 ●</b>	AP8112710	11			
125 AF1 Futura (90/92)	<b>09.72710 ●</b>	AP8112710	11			
125 Classic (95/99)	<b>09.71793 ●</b>	AP8201793	11	<b>09.74002 ●</b>	AP8102484	18
125 Pegaso (89/94)	<b>09.72710 ●</b>	AP8112710	11			
125 Red Rose (87/94)	<b>09.72710 ●</b>	AP8112710	11			
125 RS/Extrema/Replica (92/98)	<b>09.72710 ●</b>	AP8112710	11	<b>09.74007 ●</b>	AP8102512	19

□ Di primo equipaggiamento

● Adattabile

\*\* Ad esaurimento scorte

Marca, c.c., modello, anno	Commutatore bloccasterzo	Riferimento originale	Fig. pag	Kit serrature completo	Riferimento originale	Fig. pag
125 RS (99)	<b>09.71873 ●</b>	AP8124593	11	<b>09.71874 ●</b>	AP8102823	17
125 RS (00/05)	<b>09.71873 ●</b>	AP8124593	11			
125 RX (08/10)				<b>09.74005 ●</b>	861013	18
125 SX (08/10)				<b>09.74005 ●</b>	861013	18
250 RS (95/97)	<b>09.72710 ●</b>	AP8112710	11			
650 Pegaso (92/96)	<b>09.72710 ●</b>	AP8112710	11	<b>09.74007 ●</b>	AP8102512	19
650 Pegaso/3 (97/00)	<b>09.72710 ●</b>	AP8112710	11			
650 Pegaso IE (01/04)	<b>09.71873 ●</b>	AP8124593	11			
1000 SL Falco (00/03)	<b>09.71873 ●</b>	AP8124593	11			

## BENELLI

50 491 GT/Sport/Racing/ST/RR/SP/Morini (98/05)	<b>09.74301 ●</b>	R55140021A0	12	<b>09.5502 □</b>	R55020021A0	19
50/100 K2/LC	<b>09.74301 ●</b>	R55140021A0	12	<b>09.5502 □</b>	R55020021A0	19

## BETAMOTOR

50 Ark Air/LC/LC-K (94/08)				<b>09.3570 **□</b>	2803580000	19
				<b>09.73570 ●</b>		19

## DERBI

50 Senda R (00/01)				<b>09.71883 ●</b>	00H04603871	19
50 Senda R DRD EU1 (02)				<b>09.71883 ●</b>	00H04603871	19
50 Senda R DRD Racing/LTD/EU 2 (04/08)				<b>09.2218 **□</b>	00H05908251	19
50 Senda HYP DRD EVO EU2/Lim.Ed. (08/09)				<b>09.2218 **□</b>	00H05908251	19
50 Senda R X-Trem (03)				<b>09.71883 ●</b>	00H04603871	19
50 Senda R X-Trem/EU 2 (04/10)				<b>09.2218 **□</b>	00H05908251	19
50 Senda R X-Race/EU 2 (04/10)				<b>09.2218 **□</b>	00H05908251	19
50 Senda Black Edition (03)				<b>09.71883 ●</b>	00H04603871	19
50 Senda SM Black Edition (05)				<b>09.2218 **□</b>	00H05908251	19
50 Senda SM (00/01)				<b>09.71883 ●</b>	00H04603871	19
50 Senda SM DRD EU1 (02/03)				<b>09.71883 ●</b>	00H04603871	19
50 Senda SM DRD Racing/LTD/EU 2 (04/09)				<b>09.2218 **□</b>	00H05908251	19
50 Senda SM X-Trem (02/03)				<b>09.71883 ●</b>	00H04603871	19
50 Senda SM X-Trem/EU 2 (04/10)				<b>09.2218 **□</b>	00H05908251	19
50 Senda SM X-Race/EU 2 (04/10)				<b>09.2218 **□</b>	00H05908251	19
50 Atlantis Air (99/01)	<b>09.1500 **□</b>	00G05900331	12			
50 Atlantis O2 Bullet/City (03/06)	(c/cavo sella)					
50 Atlantis/City 2T Euro 2 (07/09)	<b>09.15001 **□</b>		12			
50 Atlantis 2T Bullet (10)	(s/cavo sella)					
50 Atlantis 4T Euro 2 (07)	<b>09.71500 ●</b>		12			
	(s/cavo sella)					
50 Atlantis LC (99/01)	<b>09.1500 **□</b>	00G05900331	12	<b>09.2872 **□</b>	00G05904251	20
50 Atlantis O2 (02)	(c/cavo sella)			(s/cavo sella)		
50 Atlantis O2 Red Bullet (03)	<b>09.15001 **□</b>		12	<b>09.72872 ●</b>		20
50 Atlantis O2 Two Chic (05)	(s/cavo sella)			(s/cavo sella)		
50 Atlantis 4T (04/06)	<b>09.71500 ●</b>		12			
	(s/cavo sella)					
50 GP1 Euro 2 (05)	<b>09.1500 **□</b>	00G05900331	12			
50 GP1 Race Euro 2 (05/07)	(c/cavo sella)					
	<b>09.15001 **□</b>		12			
	(s/cavo sella)					
	<b>09.71500 ●</b>		12			
	(s/cavo sella)					

Marca, c.c., modello, anno	Commutatore bloccasterzo	Riferimento originale	Fig. pag.	Kit serrature completo	Riferimento originale	Fig. pag.
100 Atlantis 2T (00/01)	<b>09.1500</b> **□	00G05900331	12	<b>09.2872</b> **□	00G05904251	20
100 Atlantis 4T (04/06)	(c/cavo sella) <b>09.15001</b> **□		12	(s/cavo sella) <b>09.72872</b> ●		20
	(s/cavo sella) <b>09.71500</b> ●		12	(s/cavo sella)		
	(s/cavo sella)					

## GILERA

50 RCR (03)				<b>09.71883</b> ●	00H04603871	19
50 RCR (06/07)				<b>09.2218</b> **□	00H05908251	19
50 SMT (03)				<b>09.71883</b> ●	00H04603871	19
50 SMT (06/07)				<b>09.2218</b> **□	00H05908251	19

## HONDA

50 GP Dio • SP Dio • SC01 • SR				<b>09.77487</b> ●	35010-GW0-020	21
50 SA Vision (88/93)				<b>09.77486</b> ●	35010-GS7-010	21
50 SFX (95/00)				<b>09.77496</b> ●	35010-GBM-850	21
				<b>09.7496</b> **●		21
50 SJ Bali (93/00)				<b>09.77495</b> ●	35010-GAV-700/W20	21
50/75 SH (87/92)	<b>09.7493</b> **●	35100-GJ4-760	13			
50 SH (93/95)				<b>09.7494</b> **●	35010-GJ3-930	21
50 SH (96/02)				<b>09.77497</b> ●	35010-GBY-910	21
50 Sky (SGX/S - 97/02)				<b>09.1933</b> **□	35010-GCG-930	20
				<b>09.71933</b> ●		20
50 SXR (98/00)				<b>09.77496</b> ●	35010-GBM-850	21
				<b>09.7496</b> **●		21
50 ZX (95)				<b>09.77487</b> ●	35010-GW0-020	21
50 ZX (96)				<b>09.7498</b> ●	35010-GBL-000	21
50 X8R-S/X8R-X (SZX - 98/02)				<b>09.73501</b> ●	35010-GCM-900	21
100 SCV Lead (03/07)	<b>09.74112</b> ●	35100-KRP-981	12			
100 SH (96/00)				<b>09.77497</b> ●	35010-GBY-910	21
125 NS F (85/86)	<b>09.7481</b> **●	35100-KR1-761	13			
125/150 Chiocciola @ (NES - 00/>)				<b>09.72097</b> ●	35010-KGF-900	20
125/150 Dylan (SES - 02/>)				<b>09.72207</b> ●	35010-KPZ-900	20
125/150 Pantheon 2 tempi (98/02)				<b>09.71752</b> ●	35010-KEY-900	20
125/150 Pantheon 4 tempi (03/07)	<b>09.2630</b> □	35100-KRJ-900	12			
125/150 PSi (PES - 06/10)				<b>09.72643</b> ●	35010-KTF-640/720	20
125/150 SH (01/04)				<b>09.21541</b> **□	35010-KPR-900	20
				(s/levismo sella)		
				<b>09.72154</b> ●		20
				(s/levismo sella)		
125/150 SH i Iniezione (05/11)				<b>09.72643</b> ●	35010-KTF-720/980	20
250 Foresight (Disco/Disco - 00/>)				<b>09.71752</b> ●	35010-KEY-900	20

## KYMC0

50 Dink/LC/Classic/Euro 2 (98/07)				<b>09.77475</b> □	35010-KBE-E000	22
				<b>09.7475</b> **●	00168927	22
50 DJ X/DJ Y/DJ W (91/00)				<b>09.77486</b> □	35010-GS7-010	22
					00169007	
50 Filly LX (01/02)	<b>09.74223</b> □	35101-KHC4-305 00168913	13			
50 People/Euro 2 (99/11)				<b>09.74227</b> □	35010-KFA6-E00	22
					00169307	
50 People S 2T/4T (05/11)	<b>09.74228</b> □	35101-LCD3-325 00168915	13			

Marca, c.c., modello, anno	Commutatore bloccasterzo	Riferimento originale	Fig. pag	Kit serrature completo	Riferimento originale	Fig. pag
50 Vitality 2T/4T (04/08)				<b>09.74225</b> □	35010-KKD6-E10 00169902	22
50 YUP/Euro 2 (02/04)				<b>09.74225</b> □	35010-KKD6-E10 00169902	22
125 Agility R12/Euro 2/Euro 3/FAT (05/10)				<b>09.74221</b> □	35010-LDF7-E10 00169181	22
125/150 Dink/LX (97/07)				<b>09.77475</b> □ <b>09.7475</b> **●	35010-KBE-E000 00168927	22 22
125/150/200 Dink Classic/Euro 2 (02/07)				<b>09.77475</b> □ <b>09.7475</b> **●	35010-KBE-E000 00168927	22 22
125/150 Gran Dink (01/02)	<b>09.74223</b> □	35101-KHC4-305 00168913	13			
125/150 Gran Dink Euro 2/Euro 3 (03/09)	<b>09.74224</b> □	35101-KKC2-325 00169056	13			
125/150 Movie XL/Euro 2/Euro 3 (01/10)				<b>09.74222</b> □	35010-KKD7-3050-M1 00168183	22
125/150 People/Euro 2/Euro 3 (99/11)				<b>09.74227</b> □	35010-KFA6-E00 00169307	22
125/200 People S/Euro 3/DD/IE (05/11)	<b>09.74228</b> □	35101-LCD3-325 00168915	13			
125/200/300 Downtown i (09/11)	<b>09.74230</b> □	35101-LEA7-315 00135048	13			
125/200/300 People GTi (10/11)	<b>09.74231</b> □	35101-LGE5-305 00135107	13			
250 Gran Dink/Euro 2 (01/07)	<b>09.74223</b> □	35101-KHC4-305 00168913	13			
250 People LC (03/06)	<b>09.74223</b> □	35101-KHC4-305 00168913	13			
250 X-Citing/IE (05/08 - carb./iniezi.)	<b>09.74229</b> □	35101-LBA2-315 00169129	13	<b>09.74226</b> □	35010-LBA2-315-M1 00169146/62	22
300 X-Citing I/R/IR (08/11)	<b>09.74229</b> □	35101-LBA2-315 00169129	13	<b>09.74226</b> □	35010-LBA2-315-M1 00169146/62	22
500 X-Citing (05/06 - carb.)	<b>09.74229</b> □	35101-LBA2-315 00169129	13	<b>09.74226</b> □	35010-LBA2-315-M1 00169146/62	22
500 X-Citing I/R (06/11 - iniezi.)	<b>09.74229</b> □	35101-LBA2-315 00169129	13	<b>09.74226</b> □	35010-LBA2-315-M1 00169146/62	22

## ITALJET

50/125 Formula/LC	<b>09.1902</b> **□	3380071	13			
50/125/180 Dragster				<b>09.1013</b> ** □	4401014	23

## MALAGUTI

50 Crosser CR1 (95/>)	<b>09.79027</b> ●	09003100	14			
50 F12 Phantom/LC/Kat/Rst/Euro 2/2.3 (94/06)	<b>09.79027</b> ●	09003100	14	<b>09.72009</b> ●	09002800	23
50 F15 Firefox/TD/Kat/Euro 2/2.3 (96/>)				<b>09.72011</b> ●	09003500	23
50 XSM Power-Up (07/10)				<b>09.74304</b> ●	09205000	23
50 XTM Power-Up (07/10)				<b>09.74304</b> ●	09205000	23
100 F12 Phantom (99/>)	<b>09.79027</b> ●	09003100	14	<b>09.72009</b> ●	09002800	23
125/150 F18 Warrior (00/>)				<b>09.72011</b> ●	09003500	23
125 X3M Enduro (08)				<b>09.74304</b> ●	09205000	23
125 X3M Motard (08)				<b>09.74304</b> ●	09205000	23
125 Madison/R/Rst Euro 2 (99/05 - Mot. Minarelli)				<b>09.71949</b> ●	09005300	23
150 Madison T (99/01)				<b>09.71949</b> ●	09005300	23
180/200 Madison R/S/Rst Euro 2 (01/03)				<b>09.71949</b> ●	09005300	23
250 Madison S (99/03 - Mot. Yamaha)				<b>09.71949</b> ●	09005300	23
250 Madison RS Rst (04 - Mot. Piaggio carb.)				<b>09.71949</b> ●	09005300	23
400 Madison/K Rst (02/05)				<b>09.71949</b> ●	09005300	23

Marca, c.c., modello, anno	Commutatore bloccasterzo	Riferimento originale	Fig. pag	Kit serrature completo	Riferimento originale	Fig. pag
<b>MBK</b>						
50 Booster (90/94 - 3WW)	<b>09.71693 ●</b>	3VL-H2501-00	14	<b>09.2021 □</b> <b>09.72021 ●</b>	5JH-H2021-00	24 24
50 Booster (01/02 - 5NT)	<b>09.71693 ●</b>	3VL-H2501-00	14	<b>09.2021 □</b> <b>09.72021 ●</b>	5JH-H2021-00	24 24
50 Booster L (01/03 - 5SX)	<b>09.71693 ●</b>	3VL-H2501-00	14	<b>09.2021 □</b> <b>09.72021 ●</b>	5JH-H2021-00	24 24
50 Booster Naked (03 - 1D12)				<b>09.72651 ●</b>	5XW-H2021-00	24
50 Booster NG (95/02 - 4SB-5FX2-5FL-5NU)				<b>09.1059 □</b> <b>09.71059 ●</b>	4SB-H2021-02/11	23 23
50 Booster NG (03/06 - 1B02)				<b>09.72314 ●</b>	1B0-H2021-00	24
50 Booster Road (94/95 - 4PA1)	<b>09.71693 ●</b>	3VL-H2501-00	14	<b>09.2021 □</b> <b>09.72021 ●</b>	5JH-H2021-00	24 24
50 Booster Rocket (97/98 - 4UP)				<b>09.1059 □</b> <b>09.71059 ●</b>	4SB-H2021-02/11	23 23
50 Booster Spirit/Euro 2/SP (96/02) (4VU-5LE/5MM-5RY2-5RH2)	<b>09.71693 ●</b>	3VL-H2501-00	14	<b>09.2021 □</b> <b>09.72021 ●</b>	5JH-H2021-00	24 24
50 Booster Spirit Euro 2 (03 - 5XW/5XX)				<b>09.72651 ●</b>	5XW-H2021-00	24
50 Booster Spirit L (03 - 5XY2/5YA2)				<b>09.72651 ●</b>	5XW-H2021-00	24
50 Booster Track (96/98 - 4YB)				<b>09.1059 □</b> <b>09.71059 ●</b>	4SB-H2021-02/11	23 23
50 Evolis (92/95)	<b>09.71693 ●</b>	4CU-H2501-00	14			
50 Flipper/Cat. (98/02)				<b>09.72732 ●</b>	5EU-H2021-00	24
50 Flipper Cat./Euro 2 (03/06)				<b>09.2214 **□</b>	5WJ-H2021-01	24
50 Fizz (94/95)	<b>09.71693 ●</b>	4CU-H2501-00	14			
50 Forte (94/95)	<b>09.74301 ●</b>	4MJ-H2501-00	15			
50 Mach-G/Euro 2 (02/08)	<b>09.71788 ●</b>	5KK-H2501-00	14			
50 Nitro (97/02)				<b>09.15201 **□</b> <b>09.71520 ●</b>	5BR-H2021-00	23 23
50 Nitro/Euro 2 (03/11)				<b>09.2312 **□</b>	5WJ-H2021-10	24
50 Ovetto (99/01)	<b>09.1500 **□</b> (c/cavo sella)	5AD-H2501-00	14			
	<b>09.15001 **□</b> (s/cavo sella)		14			
	<b>09.71500 ●</b> (s/cavo sella)		14			
50 Ovetto/Euro 2 (02/06)	<b>09.71788 ●</b>	5KK-H2501-00	14			
50 Stunt (00/02)	<b>09.71693 ●</b>	3VL-H2501-00	14	<b>09.2021 □</b> <b>09.72021 ●</b>	5JH-H2021-00	24 24
50 X-Power (03/05)	<b>09.74305 ●</b>	5WX-W2501-00	15	<b>09.74306 ●</b>	5WX-S2501-10	25
50 X-Power (06/11)	<b>09.74305 ●</b>	5WX-W2501-00	15			
100 Booster (99/>)	<b>09.7470 ●</b>	4VP-H2501-20	15			
100 Ovetto (99/>)	<b>09.71788 ●</b>	5KK-H2501-00	14			
125 Flame X (07/11)	<b>09.74303 ●</b>	4P9-H2501-02	15			
125/150 Skyliner (Disco/Tamburo - 98/00)	<b>09.1617 **□</b> (c/cavo sella)	5DS-H2501-00	14			
	<b>09.16171 **□</b> (s/cavo sella)		14			
	<b>09.71950 ●</b> (s/cavo sella)		14			
125/150/180 Skyliner (Disco/Disco - 01/>)				<b>09.729331 ●</b> (c/tappo serb.) <b>09.72933 ●</b> (s/tappo serb.)	5NR-S2501-00	24 24
125/150 Thunder (01/>)	<b>09.71909 ●</b>	5HT-H2501-00	14			



Marca, c.c., modello, anno	Commutatore bloccasterzo	Riferimento originale	Fig. pag	Kit serrature completo	Riferimento originale	Fig. pag
<b>PEUGEOT</b>						
50 Buxy (94/97)				<b>09.77499 ●</b>	752727	25
50 Elyseo (99/04)				<b>09.74501 ●</b>	739898	25
50 Elystar TDSI (03/05)				<b>09.74501 ●</b>	739898	25
50 Fox/L (94/98)				<b>09.77499 ●</b>	752727	25
50 Ludix 10 One 2T (04/>)	<b>09.74507 ●</b>	755930	15			
50 Ludix 14 Classic 2T (04/>)	<b>09.74507 ●</b>	755930	15			
50 Ludix Pro 4T (09/10)	<b>09.74507 ●</b>	755930	15			
50 Metal-X (02/>)	<b>09.74507 ●</b>	755930	15	<b>09.2007 **□</b> <b>09.72007 ●</b>	735883	25 25
50 ST Rapido/Rapido 3 (85/93)				<b>09.5695 **●</b> <b>09.75695 ●</b>	720695	25 25
50 Speedake (95/97)				<b>09.77499 ●</b>	752727	25
50 Speedfight Air/LC/Cat. (97/99) (s/antifurto elettronico)				<b>09.2007 **□</b> <b>09.72007 ●</b>	735883	25 25
50 Speedfight 2 Air/SilverSport (05/08)	<b>09.74507 ●</b>	755930	15			
50 Speedfight 2 LC WRC (05/06)	<b>09.74507 ●</b>	755930	15			
50 Speedfight 2 LC LR/Iron-X/R-CUP (07/08)	<b>09.74507 ●</b>	755930	15			
50 Speedfight 2 LC LR Ultimate Edition (08/10)	<b>09.74507 ●</b>	755930	15			
50 Squab (95/97)				<b>09.2007 **□</b> <b>09.72007 ●</b>	735883	25 25
50 Trekker On Road/Off Road (98/00)				<b>09.2007 **□</b> <b>09.72007 ●</b>	735883	25 25
50 TRK2 WRC/Furious/Rally Victories (04/09)	<b>09.74507 ●</b>	755930	15			
50 Vivacity/Cat./VSX/XR (s/antif. elettronico - 99/05)				<b>09.72008 ●</b>	739576	25
50 Vivacity 2 (s/antif. elettronico - 06/07)				<b>09.72008 ●</b>	739576	25
50 Zenith L/LM (94/96)				<b>09.77499 ●</b>	752727	25
50 Zenith N/LN/LS (94/98)				<b>09.77499 ●</b>	752727	25
50 X-Race (03/>)	<b>09.74507 ●</b>	755930	15			
100 Elyseo (00/01)				<b>09.74501 ●</b>	739898	25
100 Trekker (98)				<b>09.2007 **□</b> <b>09.72007 ●</b>	735883	25 25
100 Vivacity (s/antifurto elettronico - 99)				<b>09.72008 ●</b>	739576	25
100 Speedfight (s/antifurto elettronico - 97/00)				<b>09.2007 **□</b> <b>09.72007 ●</b>	735883	25 25
125/150 Elyseo (99/04)				<b>09.74501 ●</b>	739898	25
125/150 Elystar/Advantage/IS2/ISU2 (02/07)				<b>09.74501 ●</b>	739898	25
250 SV (Honda FES 250 - 01/>)				<b>09.71752 ●</b>	755056	25

**PIAGGIO**

50 Diesis 2T (01/>)	<b>09.1500 **□</b> (c/cavo sella)	ODN00G05900331	12			
	<b>09.15001 **□</b> (s/cavo sella)		12			
	<b>09.71500 ●</b> (s/cavo sella)		12			
100 Diesis 2T (01/>)	<b>09.1500 **□</b> (c/cavo sella)	ODN00G05900331	12	<b>09.2872 **□</b> (s/cavo sella)	ODN00G05904251	20
	<b>09.15001 **□</b> (s/cavo sella)		12	<b>09.72872 ●</b> (s/cavo sella)		20
	<b>09.71500 ●</b> (s/cavo sella)		12			

Marca, c.c., modello, anno	Commutatore bloccasterzo	Riferimento originale	Fig. pag	Kit serrature completo	Riferimento originale	Fig. pag
<b>SUZUKI</b>						
50 AP (94/97)				<b>09.79022</b> ●	37100-03A70	25
50 AY Katana/LC (97/06)				<b>09.79022</b> ●	37100-09EF0	25
125/150 UH Burgman (02/06)	<b>09.74605</b> ●	37100-49F00	15			
<b>YAMAHA</b>						
50 Aerox (97/02)				<b>09.15201</b> **□ <b>09.71520</b> ●	5BR-H2021-00	23 23
50 Aerox/Euro 2 (03/11)				<b>09.2312</b> **□	5WJ-H2021-10	24
50 Axis S/T (95/96)	<b>09.74301</b> ●	4MJ-H2501-01	15			
50 Breeze (94/95)	<b>09.71693</b> ●	4FW-H2021-02	14			
50 BW'S Bump (97/98 - 4YB)				<b>09.1059</b> □ <b>09.71059</b> ●	4SB-H2021-02/11	23 23
50 CW BW'S L (03 - 5YA1/5XY1)				<b>09.72651</b> ●	5XW-H2021-00	24
50 BW'S Naked (03 - 1D11)				<b>09.72651</b> ●	5XW-H2021-00	24
50 BW'S Next Generation/Cat. (97/02 - 4SB-5FX-5LF-5NU)				<b>09.1059</b> □ <b>09.71059</b> ●	4SB-H2021-02/11	23 23
50 BW'S Next Generation (03/06 - 1B01-2B1)				<b>09.72314</b> ●	1B0-H2021-00	24
50 BW'S Original Euro 2/SP Euro 2 (97/02) (3WW/4VV/4VU-5LE/5MM-5NT-5RH-5RY)	<b>09.71693</b> ●	3VL-H2501-00	14	<b>09.2021</b> □ <b>09.72021</b> ●	5JH-H2021-00	24 24
50 BW'S Original Euro 2 (03 - 5XX1/5XW1)				<b>09.72651</b> ●	5XW-H2021-00	24
50 BW'S R (01 - 5SX1)	<b>09.71693</b> ●	3VL-H2501-00	14	<b>09.2021</b> □ <b>09.72021</b> ●	5JH-H2021-00	24 24
50 CW RS SPY (95/98 - 4UP)				<b>09.1059</b> □ <b>09.71059</b> ●	4SB-H2021-02/11	23 23
50 DT R/X (07/10)				<b>09.74304</b> ●	13D-H2021-00	25
50 Jog R/Euro 2 (02/08)	<b>09.71788</b> ●	5KK-H2501-00	14			
50 Neo's (99/01)	<b>09.1500</b> **□ (c/cavo sella) <b>09.15001</b> **□ (s/cavo sella) <b>09.71500</b> ● (s/cavo sella)	5AD-H2501-00	14 14 14			
50 Neo's/Euro 2 (02/06)	<b>09.71788</b> ●	5KK-H2501-00	14			
50 Slider (00/02)	<b>09.71693</b> ●	3VL-H2501-00	14	<b>09.2021</b> □ <b>09.72021</b> ●	5JH-H2021-00	24 24
50 TZR/RR (03/05)	<b>09.74305</b> ●	5WX-W2501-00	15	<b>09.74306</b> ●	5WX-S2501-10	25
50 TZR/RR (06/11)	<b>09.74305</b> ●	5WX-W2501-00	15			
50 Why/Cat. (98/02)				<b>09.72732</b> ●	5EU-H2021-00	24
50 Why Cat./Euro 2 (03/06)				<b>09.2214</b> **□	5WJ-H2021-01	24
100 BW'S (99/>)	<b>09.7470</b> ●	4VP-H2501-20	15			
100 Neo's (99/>)	<b>09.71788</b> ●	5KK-H2501-00	14			
125 NXC Cygnus X (07/11)	<b>09.74303</b> ●	4P9-H2501-03	15			
125 XT R/X (07/09)				<b>09.74304</b> ●	13D-H2021-00	25
125 YZF-R (08/11)				<b>09.74302</b> ●	5D7-WH202-09	24
125/150 Majesty (Disco/Tamburo - 98/00)	<b>09.1617</b> **□ (c/cavo sella) <b>09.16171</b> **□ (s/cavo sella) <b>09.71950</b> ● (s/cavo sella)	5DS-H2501-00	14 14 14			
125/150/180 Majesty/E (Disco/Disco - 01/11)				<b>09.729331</b> ● (c/tappo serb.) <b>09.72933</b> ● (s/tappo serb.)	5NR-S2501-00	24 24
125/150 Maxster (01/>)	<b>09.71909</b> ●	5HT-H2501-00	14			

## Commutatori bloccasterzo di primo equipaggiamento e adattabili

### APRILIA

**09.2336** commutatore bloccasterzo Zadi - 3 posizioni (Q682/Q1150/Q2105)



Di primo equipaggiamento su:

**Aprilia** Amico 50/LK/LX/Sport/GL (91/98)

*Rif. orig.: AP8212336*

**09.2345** commutatore bloccasterzo Zadi - 3 posizioni (Q2345)

**09.72345** commutatore bloccasterzo adattabile - 3 posizioni



Di primo equipaggiamento su:

**Aprilia** SR 50 Di-Tech/E2 (00/04) • SR 50 IE (03/11 - mot. Piaggio iniez.)  
SR 50 H<sub>2</sub>O Racing/Sport (00/04 - mot. Suzuki/Aprilia - Carb.)

*Rif. orig.: AP8224343*

**09.71873** commutatore bloccasterzo adattabile - 3 posizioni



Adattabile su:

**Aprilia** RS 125 (99/05) • Pegaso 650 IE (01/04) • SL 1000 Falco (00/03)

*Rif. orig.: AP8124593*

**09.72337** commutatore bloccasterzo adattabile - 3 posizioni

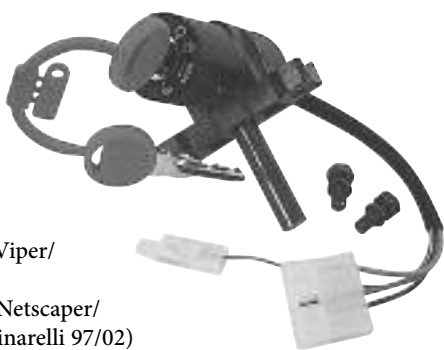

Adattabile su:

**Aprilia** SR 50/Urban/Viper/  
Replica/LC (93/96)  
SR 50 WWW/Stealth/Netscaper/  
Racing/Sport (mot. Minarelli 97/02)  
Rally 50/50 LC • Gulliver 50/LC

*Rif. orig.: AP8201600*

**09.2342** commutatore bloccasterzo Zadi - 4 posizioni (Q1197)

**09.72342** commutatore bloccasterzo adattabile - 4 posizioni



Di primo equipaggiamento su:

**Aprilia** AF1 50 Futura (90/92)

AF1 50 Replica (91/92)

AF1 50 Europa (91/92)

RS 50 (93/97) • RX 50 (90/97)

Pegaso 50 (91/94)

*Rif. orig.: AP8212342*

**09.2641** commutatore bloccasterzo Zadi - 3 posizioni (Q2641)



Di primo equipaggiamento su:

**Aprilia** SportCity 125/200/250/Euro 3 (04/08)

SportCity Cube 125/200/250/300 (08/11)

*Rif. orig.: AP8590049*

**09.71793** commutatore bloccasterzo adattabile  
3 posizioni



Adattabile su:

**Aprilia** Scarabeo 50 (mot. Minarelli - 93/06)

Scarabeo 50 Street/RST (mot. Piaggio - 05/09) • Classic 125 (95/>)

*Rif. orig.: AP8201793*

**09.72710** commutatore bloccasterzo adattabile - 3 posizioni



Adattabile su:

**Aprilia** AF1 50 Europa (90)

50 Red Rose (89/92) • 50 RS (98) • 50 RX (98/03)

AF1 125 Futura (90/92) • 125 Europa (90/91)

RS 125 (92/98) • Pegaso 125 (89/94) • Red Rose 125 (87/94)

RS 250 (95/97) • Pegaso 650/3 (92/00)

*Rif. orig.: AP8112710*

**09.74008** commutatore bloccasterzo adattabile  
3 posizioni



Adattabile su:

**Aprilia** Leonardo 125/150/250/  
300/ST (99/>)

*Rif. orig.: AP8102924*

**09.74010** commutatore bloccasterzo adattabile

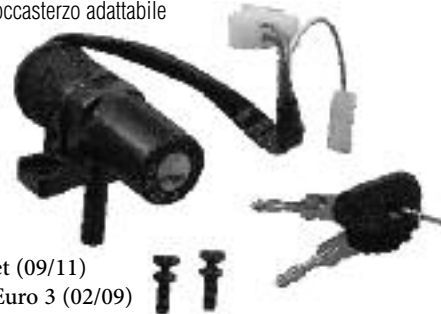

Adattabile su:

**Aprilia** Scarabeo 50 2T/Net (09/11)  
Scarabeo 50 4 tempi/RST Euro 3 (02/09)  
Scarabeo 50 Quattro/4T-4V/4T Net (09/11)  
Scarabeo 100 4 tempi/RST/Net (01/11)

*Rif. orig.: AP8104599/860579*

## BENELLI

**09.74301** commutatore bloccasterzo adattabile - 3 posizioni



Adattabile su:

**Benelli** K2 50/LC/100 • 491 50/Sport/GT/ST/RR/Racing/SP/Morini

*Rif. orig.: R55140021A0*

## DERBI/PIAGGIO

**09.1500** commutatore bloccasterzo centralizzato Zadi c/levismo sella,  
3 posizioni, c/cavo flessibile (Q1500/Q1833)



Di primo equipaggiamento su:

**Derbi** Atlantis 50/LC/02/2T/4T/Euro 2 (99/10) • Atlantis 100 2T/4T • GP1 50 Euro 2 (05/07)

**Piaggio** Dieses 50/100

*Rif. Derbi: 00G05900331 • Rif. Piaggio: ODN00G0590331*

**09.15001** commutatore bloccasterzo centralizzato Zadi c/levismo sella,  
3 posizioni - s/cavo flessibile (Q1500/Q1833)

**09.71500** commutatore bloccasterzo centralizzato adattabile c/levismo sella  
3 posizioni - s/cavo flessibile



## HONDA

**09.2630** commutatore bloccasterzo centralizzato Zadi (Q2389)



Di primo equipaggiamento su:

**Honda** Pantheon 125/150 4 tempi (03/07)

*Rif. orig.: 35100-KRJ-900*

**09.74112** commutatore bloccasterzo adattabile - 3 posizioni



Adattabile su:

**Honda** SCV 100 Lead 4T (03/07)

*Rif. orig.: 35100-KRP-981*

**09.7481** commutatore bloccasterzo adattabile  
3 posizioni - 4 faston

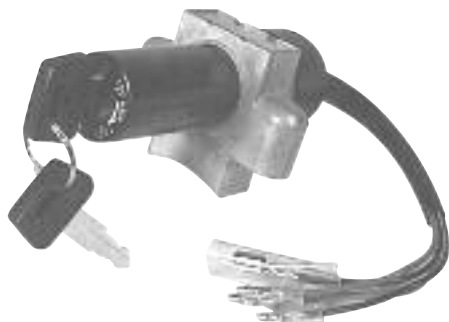

Adattabile su:

**Honda NS 125 F (85/86)**

*Rif. orig.: 35100-KR1-761*

**09.7493** commutatore bloccasterzo adattabile  
3 posizioni - 4 faston



Adattabile su:

**Honda SH 50 (87/92)**

*Rif. orig.: 35100-GJ4-760*

## KYMCO

**09.74223** commutatore bloccasterzo centralizzato



Di primo equipaggiamento su:

**Kymco Filly 50 LX (01/02) • Grand Dink 125/150 (01/02)**

**Gran Dink 250/Euro 2 (01/07) • People 250 (03/06)**

*Rif. orig.: 35101-KHC4-3050 • 00168913*

**09.74224** commutatore bloccasterzo centralizzato



Di primo equipaggiamento su:

**Kymco Gran Dink 125/150/Euro 2/Euro 3 (03/09)**

*Rif. orig.: 00169056 • 35101-KKC2-325*

**09.74228** commutatore bloccasterzo centralizzato



Di primo equipaggiamento su:

**Kymco People S 50 2T/4T (05/11)**

**People S 125/200/IE (05/11)**

*Rif. orig.: 35101-LCD3-325 • 00168915*

**09.74229** commutatore bloccasterzo centralizzato



Di primo equipaggiamento su:

**Kymco X-Citing 250/IE (05/07) • X-Citing 300 IE/R (08/11)**

**X-Citing 500 I/R (06/11)**

*Rif. orig.: 35101-LBA2-315 • 00169129*

**09.74230** commutatore bloccasterzo centralizzato



Di primo equipaggiamento su:

**Kymco Downtown 125 ie (09/11) • Downtown 200 ie (10/11)**

**Downtown 300 ie (09/11)**

*Rif. orig.: 00135048 • 35101-LEA7-315-M1*

**09.74231** commutatore bloccasterzo centralizzato



Di primo equipaggiamento su:

**Kymco People Gti 125 (10/11) • People Gti 200 (10/11)**

**People Gti 300 (10/11)**

*Rif. orig.: 00135107 • 35101-LGE5-305-M2*

## ITALJET

**09.1902** commutatore bloccasterzo Zadi - 3 posizioni (Q1002)



Di primo equipaggiamento su:

**Italjet** Formula 50/LC/125

Rif. orig.: 3380071

## MALAGUTI

**09.79027** commutatore bloccasterzo adattabile - 3 posizioni



Adattabile su:

**Malaguti** 50/100 F12 Phantom/Kat/LC/RST (94/06)

Crosser 50 CR1 (95/98)

Rif. orig.: 090.031.00

## MBK/YAMAHA

**09.1500** commutatore bloccasterzo centralizzato Zadi c/levismo sella - 3 posizioni  
c/cavo flessibile (Q1500/Q1833)

**09.15001** commutatore bloccasterzo centralizzato Zadi c/levismo sella - 3 posizioni  
s/cavo flessibile (Q1500/Q1833)

**09.71500** commutatore bloccasterzo centralizzato adattabile c/levismo sella - 3 posizioni  
s/cavo flessibile

Di primo equipaggiamento su:

**MBK** Ovetto 50 (99/01)

**Yamaha** Neo's 50 (99/01)

Rif. MBK/Yamaha: 5AD-H2501-00



**09.1617** commutatore bloccasterzo centralizzato Zadi c/levismo sella  
3 posizioni - c/cavo flessibile (Q1617)

**09.16171** commutatore bloccasterzo centralizzato Zadi c/levismo sella  
3 posizioni - s/cavo flessibile (Q1617)

**09.71950** commutatore bloccasterzo centralizzato adattabile c/levismo sella  
3 posizioni - s/cavo flessibile



Di primo equipaggiamento su:

**MBK** Skyliner 125/150 (98/00)

**Yamaha** Majesty 125/150 (98/00)

Rif. MBK/Yamaha: 5DS-H2501-00

**09.71693** commutatore bloccasterzo adattabile - 3 posizioni



Adattabile su:

**MBK** Booster 50 (90/94)

Booster 50 Road (94/95)

Booster 50 (01/02) • Booster L (01/03)

Evolis 50 (92/95) • Fizz 50 (94/95) • Stunt 50 (00/02)

**Yamaha** Breeze 50 (94/95)

BW'S 50 Original (97/02) • BW'S R (01) • Slider 50 (00/02)

Rif. MBK/Yamaha: 3VL-H2501-00 • 4PC-H2501-00 • 4CU-H2501-00

**09.71788** commutatore bloccasterzo centralizzato adattabile  
c/levismo sella - 3 posizioni



Di primo equipaggiamento su:

**MBK** Ovetto 50 (02/06) • Mach 50 G (02/08) • Ovetto 100 (99/>)

**Yamaha** Neo's 50 (02/06) • Jog 50 R (02/08) • Neo's 100 (99/>)

Rif. MBK/Yamaha: 5KK-H2501-00

**09.71909** commutatore bloccasterzo centralizzato adattabile  
3 posizioni



Adattabile su:

**MBK** Thunder 125/150 (01/>)

**Yamaha** Maxster 125/150 (01/>)

Rif. MBK/Yamaha: 5HT-H2501-00

**09.74301** commutatore bloccasterzo adattabile - 3 posizioniAdattabile su:**MBK** 50 Forte**Yamaha** Axis 50*Rif. orig.: 4MJ-H2501-00***09.74303** commutatore bloccasterzo centralizzato adattabileAdattabile su:**MBK** 125 Flame X (07/11)**Yamaha** NXC 125 Cygnus X (07/11)*Rif. orig.: 4P9H25010200***09.74305** commutatore bloccasterzo adattabileAdattabile su:**MBK** X-Power 50 (03/11)**Yamaha** TZR 50/RR (03/11)*Rif. orig.: 5WXW25010000***09.7470** commutatore bloccasterzo centralizzato adattabileAdattabile su:**MBK** Booster 100**Yamaha** BW'S 100*Rif. orig.: 4VP-H2501-20*

## PEUGEOT

**09.74507** commutatore bloccasterzo adattabile - 3 posizioniAdattabile su:**Peugeot** 50 Ludix 10 One (04/>) • 50 Ludix 14 Classic (04/>) • 50 Ludix Pro 4T (09/10)

Metal-X 50 • X-Race 50 • 50 Speedfight 2 aria (05/06) • Speedfight 2 LC (05/10)

50 TRK2/WRC (04/08)

*Rif. orig.: 755930*

## SUZUKI

**09.74605** commutatore bloccasterzo centralizzato adattabileAdattabile su:**Suzuki** UH 125 Burgman (02/06) • UH 150 Burgman (02/06)*Rif. orig.: 37100-49F00*

## Kit serrature di primo equipaggiamento e adattabili

### APRILIA

**09.1492** kit Zadi 3 pz.: bloccasterzo, sella, bauletto (Q1004)

**09.71492** kit adattabile 3 pz.:  
bloccasterzo, sella, bauletto



Di primo equipaggiamento su:

**Aprilia** SR 50/WWW/Netscaper/Stealth/  
Racing/Sport (mot. Minarelli - 94/02) • Rally 50/50 LC

Rif. orig.: AP8201845

**09.1602** kit Zadi 3 pz.: bloccasterzo, sella, tappo serbatoio (Q1559/Q1602)

**09.71602** kit adattabile 3 pz.: bloccasterzo, sella, tappo serbatoio



Di primo equipaggiamento su:

**Aprilia** RS 50 (99/05)  
RS 50 Tuono (03/05)

Rif. orig.: AP8202358

**09.2612** kit Zadi 4 pz.: bloccasterzo, sella, sportellino, bauletto post. (Q2388)

**09.72612** kit adattabile 3 pz.: bloccasterzo, sella, sportellino

**09.2346** kit Zadi 4 pz.: bloccasterzo, sella, portaoggetti,  
bauletto post. (Q2346)



Di primo equipaggiamento su:

**Aprilia** Scarabeo 50 Di-Tech (01/07)

Rif. orig.: AP8202283

Di primo equipaggiamento su:

**Aprilia** Scarabeo 50 4 tempi/Rst Euro 3/4T-4V/Net (02/11)  
Scarabeo 100 4T/Net (01/11)

Rif. orig.: AP8202329/85180R

**09.2640** kit Zadi 3 pz.: bloccasterzo, sella, portaoggetti (Q2640)

**09.72640** kit adattabile 3 pz.: bloccasterzo, sella, portaoggetti



Di primo equipaggiamento su:

**Aprilia** SportCity 125/200/250 (04/08)  
SportCity Cube 125/200/250/300 (08/11)

Rif. orig.: AP8104726/85181R

**09.71070** kit adattabile 3 pz.: bloccasterzo, sella, bauletto



Adattabile su:

**Aprilia** Leonardo 125/150 (96/98)

Rif. orig.: AP8102412



**09.71732** kit adattabile 3 pz.: bloccasterzo, sella, bauletto



Adattabile su:

**Aprilia** Gulliver 50/LC

Rif. orig.: AP8201732

**09.71842** kit adattabile 2 pz.: bloccasterzo, bauletto, s/levismo sella, s/cavo flessibile



Adattabile su:

**Aprilia** Scarabeo 125/150/200 (99/04 - mot. Rotax)

Scarabeo 125/200 Euro 2 (03 - mot. Piaggio)

Rif. orig.: AP8102841

**09.71850** kit adattabile 3 pz.: bloccasterzo, bauletto, portaoggetti



Adattabile su:

**Aprilia** Habana 50/Custom (99/>) • Mojito 50/Custom (99/05)

Mojito 125/150/Custom (03/07)

Rif. orig.: AP8202149

**09.71852** kit adattabile 3 pz.: bloccasterzo, bauletto, portaoggetti



Adattabile su:

**Aprilia** Habana 125/Custom (99/02) • Mojito 125/Custom (95/02)

Rif. orig.: AP8104050

**09.71840** kit adattabile 3 pz.: bloccasterzo, sella, bauletto



Adattabile su:

**Aprilia** Leonardo 125/150/ST (99/04)

Rif. orig.: AP8102923

**09.71843** kit adattabile 3 pz.: bloccasterzo, bauletto, sella



Adattabile su:

**Aprilia** Leonardo 250/300/ST (99/>)

Rif. orig.: AP8102877

**09.71851** kit adattabile 3 pz.: bloccasterzo, bauletto, sella



Adattabile su:

**Aprilia** SR 125/150 (99/01)

Rif. orig.: AP8102975

**09.71874** kit adattabile 3 pz.: bloccasterzo, sella, tappo serbatoio c/levismo sella



Adattabile su:

**Aprilia** RS 125 (99)

Rif. orig.: AP8102823

**09.72014** kit adattabile 3 pz.: bloccasterzo, sella, bauletto



Adattabile su:

**Aprilia** Sonic 50/GP (H<sub>2</sub>O - 98/08)

*Rif. orig.: AP8202014*

**09.72344** kit adattabile 3 pz.: bloccasterzo, sella, portaoggetti



Adattabile su:

**Aprilia** SR 50 Di-Tech/E2 (00/04)

SR 50 H<sub>2</sub>O Racing/Sport (00/> - Mot. Suzuki/Aprilia - Carb.)

SR 50 Street IE (mot. Piaggio iniez. - 03/11)

*Rif. orig.: AP8202386*

**09.72611** kit adattabile 4 pz.: bloccasterzo, sella, bauletto, sportellino



Di primo equipaggiamento su:

**Aprilia** Atlantic 125/200/250/300 (03/11)

Atlantic 400/500 Sprint (05/10)

*Rif. orig.: AP8104418*

**09.74002** kit adattabile 3 pz.: bloccasterzo, tappo serbatoio, sella



Adattabile su:

**Aprilia** Classic 125 (95/99)

*Rif. orig.: AP8102484*

**09.74003** kit adattabile 3 pz.: bloccasterzo, sella, portaoggetti



Adattabile su:

**Aprilia** SR 50 Factory IE (04/06 - mot. Di-Tech)

SR 50 R Factory IE (04/11 - mot. Piaggio iniezione)

SR 50 H<sub>2</sub>O New Di-Tech (04/06)

*Rif. orig.: AP8202396*

**09.74004** kit adattabile 3 pz.: bloccasterzo, bauletto, sella



Adattabile su:

**Aprilia** Scarabeo 125/250 Euro 2 (04/06 - mot. Piaggio)

*Rif. orig.: AP8104824*

**09.74005** kit adattabile 2 pz.: bloccasterzo, sportellino



Adattabile su:

**Aprilia** RX/SX 50 (06/11) • RX/SX 125 (08/10)

*Rif. orig.: 861013*

**09.74006** kit adattabile 3 pz.: bloccasterzo, tappo serbatoio, sella



Adattabile su:

**Aprilia** RS 50 (06/10)

*Rif. orig.: 861029 (86151R)*

**09.74007** kit adattabile 3 pz.: bloccasterzo, tappo serbatoio, sella



Adattabile su:

**Aprilia** RS 125 (92/98) • Pegaso 650 (92/96)

*Rif. orig.: AP8102512*

**09.74009** kit adattabile 2 pz.: bloccasterzo, bauletto



Adattabile su:

**Aprilia** Scarabeo 125/200 Euro 3 (06/07)

*Rif. orig.: 852139*

## BENELLI

**09.5502** kit Zadi 3 pz.: bloccasterzo, sella, bauletto (Q1599)



Di primo equipaggiamento su:

**Benelli** 491 GT/Sport/Racing/ST/RR/SP/Morini (98/05) • K2 50/LC (98/01) • K2 100 (99/01)

*Rif. orig.: 55020021A0*

## BETAMOTOR

**09.3570** kit Zadi 2 pz.: bloccasterzo, sella (Q1219)

**09.73570** kit adattabile 2 pz.: bloccasterzo, sella



Di primo equipaggiamento su:

**Betamotor** 50 Ark/Ark LC/LC-K (96/08)

*Rif. orig.: 2803580000*

## DERBI/GILERA/PIAGGIO

**09.71883** kit adattabile 3 pz.: bloccasterzo, sella, fianchetto



Adattabile su:

**Derbi** Senda 50 R/SM/DRD (99/03)

**Gilera** 50 RCR (03) • 50 RCR (06/07) • 50 SMT (03) • 50 SMT (06/07)

*Rif. orig.: 00H04603871*

**09.2218** kit Zadi 2 pz.: bloccasterzo, sella (Q2218)



Di primo equipaggiamento su:

**Derbi** Senda 50 R/SM/DRD/X-Trem/X-Race (02/10)

*Rif. orig.: 00H05908251*

**09.2872** kit Zadi 2 pz.: bloccasterzo, bauletto, c/levismo sella (Q1872)

**09.72872** kit adattabile 2 pz.: bloccasterzo, bauletto, c/levismo sella



Di primo equipaggiamento su:

**Derbi** Atlantis 50 LC (95/01) • Atlantis 50 02/Two Chic/Red Bullet (02/05)

Atlantis 50 4T (04/06) • Atlantis 100 2T/4T

**Piaggio** Diesis 100

Rif. Derbi: 00G05904251

Rif. Piaggio: 0DN00G05906251

## HONDA

**09.1933** kit Zadi 2 pz.: bloccasterzo, sella (Q1460)

**09.71933** kit adattabile 2 pz.: bloccasterzo, sella



Di primo equipaggiamento su:

**Honda** Sky 50/De Luxe

Rif. orig.: 35010-GCG-930

**09.71752** kit adattabile 4 pz.: bloccasterzo, sella, bauletto, sportello benzina



Adattabile su:

**Honda** Pantheon 125/150 2 tempi (98/02) • Foresight 250 (00/>)

Rif. orig.: 35010-KEY-900 • 35100-KFG-860/D10

**09.72207** kit adattabile 2 pz.: bloccasterzo, bauletto



Adattabile su:

**Honda** Dylan 125/150

Rif. orig.: 35010-KPZ-900

**09.21541** kit Zadi 3 pz.: bloccasterzo, bauletto, sportello benzina

**09.72154** kit adattabile 3 pz.: bloccasterzo, bauletto, sportello benzina



Di primo equipaggiamento su:

**Honda** SH 125/150 (01/04)

Rif. orig.: 35010-KPR-900

**09.72097** kit adattabile 3 pz.: bloccasterzo, sella, bauletto



Adattabile su:

**Honda** @ 125/150 Chiocciola (NES)

Rif. orig.: 35010-KGF-900

**09.72643** kit adattabile 2 pz.: bloccasterzo, bauletto



Di primo equipaggiamento su:

**Honda** SH 125/150 Iniezione (05/11) • 125/150 Psi (06/10)

Rif. orig.: 35010-KTF-640 • 35010-KTF-720 • 35010-KTF-980

**09.73501** kit adattabile 2 pz.: bloccasterzo, sella



Adattabile su:

**Honda 50 X8RS • 50 X8RX**

Rif. orig.: 35010-GCM-900

**09.77486** kit adattabile 3 pz.: bloccasterzo, sella, bauletto



Adattabile su:

**Honda SA 50 Vision**

Rif. orig.: 35010-GS7-010

**09.77487** kit adattabile 3 pz.: bloccasterzo, sella, bauletto



Adattabile su:

**Honda 50 Dio • SP (90/91) • SC01 • SR • ZX (95)**

Rif. orig.: 35010-GW0-020

**09.7494** kit adattabile 2 pz.: bloccasterzo, bauletto

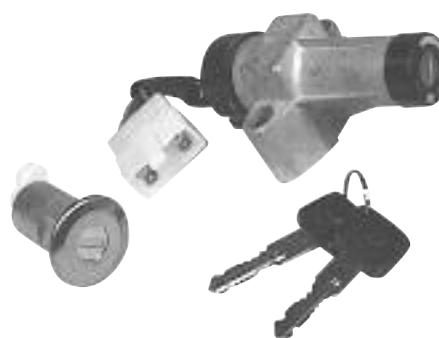

Adattabile su:

**Honda SH 50 (93/95)**

Rif. orig.: 35010-GJ3-930

**09.77495** kit adattabile 4 pz.: bloccasterzo, sella, bauletto, benzina



Adattabile su:

**Honda Bali 50**

Rif. orig.: 35010-GAV-700

**09.7496** kit adattabile 2 pz.: bloccasterzo, bauletto



Adattabile su:

**Honda SFX 50 (95/98) • SXR 50 (98/00)**

Rif. orig.: 35010-GBM-850

**09.77497** kit adattabile 3 pz.: bloccasterzo, sella, bauletto



Adattabile su:

**Honda SH 50 Fifty (96/>) • SH 100**

Rif. orig.: 35010-GBY-910

**09.7498** kit adattabile 3 pz.: bloccasterzo, sella, bauletto



Adattabile su:

**Honda 50 ZX (96)**

Rif. orig.: 35010-GBL-000

## KYMC0

09.74221 kit 2 pz.: bloccasterzo, sella, c/levismo sella



Di primo equipaggiamento su:

**Kymco** Agility 125 4T R12/Euro 3 (05/09 - ruote 12")

Rif. orig.: 00169181 • 35010-LDF7-E10

09.74222 kit 2 pz.: bloccasterzo, tappo serbatoio



Di primo equipaggiamento su:

**Kymco** Movie 125/150 XL/Euro 2 (01/06)

Movie 125/150 Euro 3 (06/09)

Rif. orig.: 00168183 • 35010-KKD7-3050-M1

09.74225 kit 2 pz.: bloccasterzo, sella



Di primo equipaggiamento su:

**Kymco** Vitality 50 2T/4T (04/08) • Yup 50/Euro 2 (02/04)

Rif. orig.: 00169902 • 35010-KKD6-E10

09.74226 kit 2 pz.:  
bloccasterzo, bauletto



Di primo equipaggiamento su:

**Kymco** X-Citing 250/300/500/I/R (05/11)

Rif. orig.: 00169146 • 35010-LBA2-315-M1

09.74227 kit 3 pz.: bloccasterzo, sella, bauletto



Di primo equipaggiamento su:

**Kymco** People 50/125/150/Euro 2/Euro 3 (99/11)

Rif. orig.: 35010-KFA6-E000 • 00169307

09.77475 kit 3 pz.: bloccasterzo, sella, tappo serbatoio

09.7475 kit adattabile 3 pz.: bloccasterzo, sella, tappo serbatoio



Di primo equipaggiamento su:

**Kymco** Dink 50/Classic Euro 2 (98/07)

Dink 125/150 (96/98) • Dink LX 125/150 (98/07)

Dink Classic 125/150/200/Euro 2 (02/07)

Rif. orig.: 35010-KBE-E000 • 00168927

09.77486 kit 3 pz.: bloccasterzo, sella, bauletto



Di primo equipaggiamento su:

**Kymco** 50 DJX/DJY/DJW

Rif. orig.: 35010-GS7-010 • 00169007

## ITALJET

**09.1013** kit Zadi 5 pz.: bloccasterzo, sella, serbatoio, fiancate (Q1445)

Di primo equipaggiamento su:

**Italjet** Dragster 50/125/180

Rif. orig.: 4401014



## MALAGUTI

**09.71949** kit adattabile 4 pz.: bloccasterzo, tappo serbatoio, sella, bauletto



Adattabile su:

**Malaguti** Madison 125/150 (99/05) • Madison 180/200/250 (99/05)

Madison 400 (03/05)

Rif. orig.: 09005300

**09.72011** kit adattabile 3 pz.: bloccasterzo, sella, bauletto, s/levismo sella



Adattabile su:

**Malaguti** 50 F15 Firefox/TD/Kat/Euro 2/2.3 (96/06)

125/150 F18 Warrior (00/05)

Rif. orig.: 09003500

## MBK/YAMAHA

**09.1059** kit Zadi 2 pz.: bloccasterzo, sella (Q1059)

**09.71059** kit adattabile 2 pz.: bloccasterzo, sella



Di primo equipaggiamento su:

**MBK** 50 Booster Track (97/98)

50 Booster Rocket (97/98) • 50 Booster NG/Cat. (95/02)

**Yamaha** 50 BW'S Bump (97/98) • 50 CW RS Spy (97/98)

50 BW'S Next Generation (97/02)

Rif. MBK/Yamaha: 4SB-H2021-02/11

**09.72009** kit adattabile 3 pz.: bloccasterzo, sella, bauletto



Adattabile su:

**Malaguti** 50 F12 Phantom/LC/Kat/RST (94/06)

100 F12 Phantom (99/00)

Rif. orig.: 09002800

**09.74304** kit adattabile 2 pz.: bloccasterzo, tappo serbatoio



Adattabile su:

**Malaguti** XTM 50 Power-up (07/10)

XSM 50 Power-up (07/10) • X3M 125 Enduro/Motard (08)

Rif. orig.: 09205000

**09.15201** kit Zadi 3 pz.: bloccasterzo, tappo benzina, bauletto, c/levismo sella (Q1520)

**09.71520** kit adattabile 3 pz.: bloccasterzo, tappo benzina, bauletto, c/levismo sella



Di primo equipaggiamento su:

**MBK** Nitro 50 (97/02)

**Yamaha** Aerox 50 (97/02)

Rif. MBK/Yamaha: 5BR-H2021-00

**09.2021** kit Zadi 2 pz.: bloccasterzo, sella (Q694/Q1063)

**09.72021** kit adattabile 2 pz.: bloccasterzo, sella



Di primo equipaggiamento su:

**MBK** 50 Booster (90/94) • 50 Booster Road (94/95) • 50 Booster (01/02)  
50 Booster Spirit (96/02) • 50 Booster L (01/03) • 50 Stunt (00/02)

**Yamaha** 50 BW'S Original (97/02) • 50 BW'S R (01) • 50 Slider (00/02)

Rif. MBK/Yamaha: 5JH-H2021-00

**09.2214** kit Zadi 2 pz.: bloccasterzo, bauletto, s/levismo sella (Q2214)



Di primo equipaggiamento su:

**MBK** 50 Flipper Cat./Euro 2 (03/06)

**Yamaha** 50 Why Cat./Euro 2 (03/06)

Rif. MBK/Yamaha: 5WJ-H2021-01

**09.2312** kit Zadi 3 pz.: bloccasterzo, tappo benzina, bauletto, s/levismo sella (Q2312)



Di primo equipaggiamento su:

**MBK** 50 Nitro/Euro 2 (03/11)

**Yamaha** 50 Aerox/Euro 2 (03/11)

Rif. orig.: 5WJ-H2021-10

**09.72314** kit adattabile 2 pz.: bloccasterzo, sella (Q2314)



Adattabile su:

**MBK** Booster 50 NG (03/06)

**Yamaha** BW'S 50 Next Generation (03/06)

Rif. MBK/Yamaha: 1BO-H2021-00

**09.72651** kit adattabile 2 pz.: bloccasterzo, sella



Adattabile su:

**MBK** Booster 50 Spirit L (03)/Spirit Euro 2 (03)

Booster 50 Naked (03)

**Yamaha** BW'S 50 Original Euro 2 (03)

BW'S 50 L (03) • BW'S 50 Naked (03)

Rif. MBK/Yamaha: 5XW-H2021-00

**09.72732** kit adattabile 2 pz.: bloccasterzo, bauletto, c/levismo sella s/cavo flessibile



Adattabile su:

**MBK** 50 Flipper (98/02)

**Yamaha** 50 Why (98/02)

Rif. MBK/Yamaha: 5EU-H2021-00

**09.729331** kit adattabile 3 pz.: bloccasterzo, portaoggetti, c/tappo serbatoio

**09.72933** kit adattabile 2 pz.: bloccasterzo, portaoggetti, s/tappo serbatoio



Adattabile su:

**MBK** Skyliner 125/150/180 (01/10)

**Yamaha** Majesty 125/150/180/E (01/10)

Rif. MBK/Yamaha: 5NR-S2501-00

**09.74302** kit adattabile 2 pz.: bloccasterzo, sella



Adattabile su:

**Yamaha** YZF 125 R (08/11)

Rif. orig.: 5D7WH2020900



**09.74304** kit adattabile 2 pz.: bloccasterzo, tappo serbatoio



Adattabile su:

**Yamaha** DT 50 R/X (07/10) • XT 125 R/X (07/09)

*Rif. orig.: 13DH20210000 (13CH20210000)*

**09.74306** kit adattabile 3 pz.: bloccasterzo, tappo serbatoio, sella



Adattabile su:

**MBK** X-Power 50 (03/05)

**Yamaha** TZR 50 (03/05)

*Rif. orig.: 5WXS25011000*

## PEUGEOT

**09.71752** kit adattabile 4 pz.: bloccasterzo, sella, bauletto, sportello benzina



Adattabile su:

**Peugeot** SV 250 (01/>)

*Rif. orig.: 755056*

**09.2007** kit Zadi 2 pz.: bloccasterzo, sella (Q2007)

**09.72007** kit adattabile 2 pz.: bloccasterzo, sella

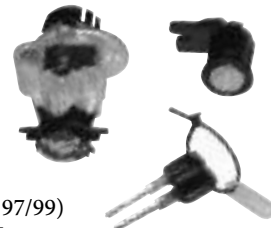

Di primo equipaggiamento su:

**Peugeot** 50 Squab (95/97)

50 Speedfight/LC/Cat. (s/immobilizer - 97/99)

50 Trekker On/Off (98/00) • 50 Metal-X

100 Speedfight (s/immobilizer - 97/00) • 100 Trekker (98)

*Rif. orig.: 735883*

**09.72008** kit adattabile 2 pz.: bloccasterzo, sella



Adattabile su:

**Peugeot** 50 Vivacity (s/immobilizer - 99/05)

50 Vivacity 2 (s/immobilizer - 06/07)

100 Vivacity (99 - s/immobilizer)

*Rif. orig.: 739576*

**09.5695** kit adattabile 3 pz.: bloccasterzo, sella, bauletto

**09.75695** kit adattabile 3 pz.: bloccasterzo, sella, bauletto

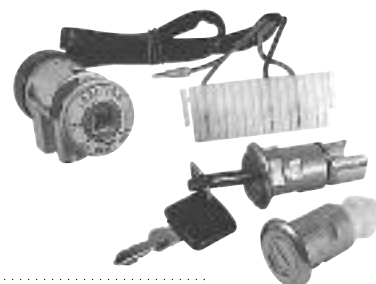

Adattabile su:

**Peugeot** Rapido 50 • Rapido 3

*Rif. orig.: 720695*

**09.74501** kit adattabile 3 pz.: bloccasterzo, sella, bauletto



Adattabile su:

**Peugeot** Elyseo 50/100/125/150 • Elystar 50/125/150

*Rif. orig.: 739898*

**09.77499** kit adattabile 2 pz.: bloccasterzo, sella



Adattabile su:

**Peugeot** 50 Buxy • 50 Zenith • 50 Speedake • 50 Fox

*Rif. orig.: 752727*

## SUZUKI

**09.79022** kit adattabile 2 pz.: bloccasterzo, sella



Adattabile su:

**Suzuki** AP 50 (94/97) • Katana 50/LC (97/06)

*Rif. orig.: 37100-09EF0 • 45011-09EF0*

## Tabella applicazioni serrature Derbi/Gilera/Piaggio

Marca, c.c., modello, anno	Cod. SGR	Composizione	Riferimento originale	Fig. pag.
<b>DERBI SCOOTER</b>				
125 Boulevard/Euro 3 (02/07)	09.74401 ●	set 3 cilindretti	575124	35
150 Boulevard/Euro 3 (02/07)	09.74401 ●	set 3 cilindretti	575124	35
200 Boulevard (05)	09.74401 ●	set 3 cilindretti	575124	35
<b>GILERA</b>				
50 Bullit	25.2006 □	sella	324301	34
50 Easy Moving (95/96)	25.0039 □	bloccasterzo-sella-bauletto	295652	34
50 GSA	25.0004 □	bloccasterzo Zadi	139330	32
50 ICE (01/05)	09.73594 ●	serie 2 pz.	576718	35
50 Runner/Poggiali/SP (97/04)	09.73594 ●	serie 2 pz.	576718	35
50 Runner Purejet (02/04)	09.73594 ●	serie 2 pz.	576718	35
50 Stalker/Naked/Spec.Ed. (97/11)	25.0037 □ 09.70037 ●	bloccasterzo-sella bloccasterzo-sella	573785 573785	33 33
50 Storm (94/95)	25.00132 □ 09.700132 ●	set 3 cilindretti set 3 cilindretti	179292 179292	33 33
50 Storm (94/95)	25.0014 □	1 cilindretto	196486	33
50 Storm Euro 2 (07/08)	25.0037 □ 09.70037 ●	bloccasterzo-sella bloccasterzo-sella	573785 573785	33 33
50 Typhoon/X/XR (94/00)	25.00132 □ 09.700132 ●	set 3 cilindretti set 3 cilindretti	179292 179292	33 33
50 Typhoon/X/XR (94/00)	25.0014 □	1 cilindretto	196486	33
125 Runner FX 2T (97/02)	09.73594 ●	serie 2 pz.	576718	35
125 Typhoon/X/XR (95/00)	25.00132 □ 09.700132 ●	set 3 cilindretti set 3 cilindretti	179292 179292	33 33
125 Typhoon/X/XR (95/00)	25.0014 □	1 cilindretto	196486	33
180 Runner FXR 2T (97/02)	09.73594 ●	serie 2 pz.	576718	35
<b>PIAGGIO SCOOTER</b>				
50 Fly 2T/4T (05/11)	09.73594 ●	serie 2 pz.	573512	35
50 Free (92/94)	25.00132 □ 09.700132 ●	set 3 cilindretti set 3 cilindretti	179292 179292	33 33
50 Free (92/94)	25.0014 □	1 cilindretto	196486	33
50 Free/FL/Delivery (95/02)	25.0037 □ 09.70037 ●	bloccasterzo-sella bloccasterzo-sella	2577032/573785 2577032/573785	33 33
50 Free/FL/Delivery (95/02)	25.0073 □	serie 3 pz.	298786	35
50 Liberty 2T/4T/Rst/PT/Sport/MOC/Elle (97/11)	09.73594 ●	serie 2 pz.	573512	35
50 NRG (94/96)	25.00132 □ 09.700132 ●	set 3 cilindretti set 3 cilindretti	179292 179292	33 33
50 NRG (94/96)	25.0014 □	1 cilindretto	196486	33
50 NRG MC2/Extreme/MC3/Purejet (96/04)	25.0037 □ 09.70037 ●	bloccasterzo-sella bloccasterzo-sella	2577032/573785 2577032/573785	33 33
50 NTT (95/96)	25.0037 □ 09.70037 ●	bloccasterzo-sella bloccasterzo-sella	2577032/573785 2577032/573785	33 33
50 Quartz (92/96)	25.00132 □ 09.700132 ●	set 3 cilindretti set 3 cilindretti	179292 179292	33 33
50 Quartz (92/96)	25.0014 □	1 cilindretto	196486	33
50 Scatto (92/93)	25.0014 □	1 cilindretto	196486	33

□ Di primo equipaggiamento

● Adattabile

Marca, c.c., modello, anno	Cod. SGR	Composizione	Riferimento originale	Fig. pag.
50 Sfera/Maquillage 2/FL Rst (91/97)	25.00132 <input type="checkbox"/>	set 3 cilindretti	179292	33
	09.700132 <input checked="" type="checkbox"/>	set 3 cilindretti	179292	33
50 Sfera/Maquillage 2/FL Rst (91/97)	25.0014 <input type="checkbox"/>	1 cilindretto	196486	33
50 Sfera FL Rst (95/97 - Olanda)	25.0073 <input type="checkbox"/>	serie 3 pz.	298786	35
50 Typhoon (01/04)	25.00132 <input type="checkbox"/>	set 3 cilindretti	179292	33
	09.700132 <input checked="" type="checkbox"/>	set 3 cilindretti	179292	33
50 Typhoon (01/04)	25.0014 <input type="checkbox"/>	1 cilindretto	196486	33
50 Typhoon (05/09)	25.0037 <input type="checkbox"/>	bloccasterzo-sella	2577032/573785	33
	09.70037 <input checked="" type="checkbox"/>	bloccasterzo-sella	2577032/573785	33
50 Velofax (96/99)	25.0037 <input type="checkbox"/>	bloccasterzo-sella	2577032/573785	33
	09.70037 <input checked="" type="checkbox"/>	bloccasterzo-sella	2577032/573785	33
50 Vespa ET2 (97/05)	09.73594 <input checked="" type="checkbox"/>	serie 2 pz.	573905	35
50 Vespa ET4 (00/05)	09.73594 <input checked="" type="checkbox"/>	serie 2 pz.	573905	35
50 Vespa LX/LXV 2T/4T/4T-4V/Touring (05/11)	09.73594 <input checked="" type="checkbox"/>	serie 2 pz.	573905	35
50 Vespa S 2T/4T-4V/College (07/11)	09.73594 <input checked="" type="checkbox"/>	serie 2 pz.	573905	35
50 Zip Base/Rst (92/99)	25.0039 <input type="checkbox"/>	bloccasterzo-sella-bauletto	295652	34
50 Zip Fast Rider/Rst (93/97)	25.0039 <input type="checkbox"/>	bloccasterzo-sella-bauletto	295652	34
50 Zip & Zip Bimodale (94/97)	25.0039 <input type="checkbox"/>	bloccasterzo-sella-bauletto	295652	34
50 Zip SP (96/00)	25.0039 <input type="checkbox"/>	bloccasterzo-sella-bauletto	295652	34
50 Zip SP (01/09)	09.73594 <input checked="" type="checkbox"/>	serie 2 pz.	573512	35
50 Zip Cat 2T (00/11)	09.73594 <input checked="" type="checkbox"/>	serie 2 pz.	573512	35
50 Zip 4T (00/11)	09.73594 <input checked="" type="checkbox"/>	serie 2 pz.	573512	35
100 Fly 4T (06/07)	09.73594 <input checked="" type="checkbox"/>	serie 2 pz.	573512	35
100 Free 4T (02/>)	25.0037 <input type="checkbox"/>	bloccasterzo-sella	2577032/573785	33
	09.70037 <input checked="" type="checkbox"/>	bloccasterzo-sella	2577032/573785	33
100 Zip 4T (06/10)	09.73594 <input checked="" type="checkbox"/>	serie 2 pz.	573512	35
125 Carnaby (07/11)	09.74400 <input checked="" type="checkbox"/>	set 2 cilindretti	654373	35
125 Fly Euro 3 (07/11 - s/immobilizer)	09.73594 <input checked="" type="checkbox"/>	serie 2 pz.	573512	35
125 Hexagon 2T (94/97)	25.0071 <input type="checkbox"/>	serie 3 pz.	296881	34
125 Hexagon LX 2T (98/99)	09.73613 <input checked="" type="checkbox"/>	serie 3 pz.	575123	35
125 Hexagon LX4 4T (98/99)	09.73613 <input checked="" type="checkbox"/>	serie 3 pz.	575123	35
125 Liberty (98/02 - s/immobilizer)	09.73594 <input checked="" type="checkbox"/>	serie 2 pz.	573512	35
125 Liberty MOC/Elle (09/11 - s/immobilizer)	09.73594 <input checked="" type="checkbox"/>	serie 2 pz.	573512	35
125 Sfera FL (95/97)	25.00132 <input type="checkbox"/>	set 3 cilindretti	179292	33
	09.700132 <input checked="" type="checkbox"/>	set 3 cilindretti	179292	33
125 Sfera FL (95/97)	25.0014 <input type="checkbox"/>	1 cilindretto	196486	33
125 Skipper 2T (94/97)	25.00132 <input type="checkbox"/>	set 3 cilindretti	179292	33
	09.700132 <input checked="" type="checkbox"/>	set 3 cilindretti	179292	33
125 Skipper 2T (94/97)	25.0014 <input type="checkbox"/>	1 cilindretto	196486	33
125 Skipper LX 2T (98/99)	09.74401 <input checked="" type="checkbox"/>	set 3 cilindretti	575124	35
125 Skipper ST 4T (00/02)	09.74401 <input checked="" type="checkbox"/>	set 3 cilindretti	575124	35
125 Vespa ET4 (96/98 - s/immobilizer)	09.73594 <input checked="" type="checkbox"/>	serie 2 pz.	573905	35
125 Vespa S/IE/College (07/11 - s/immobilizer)	09.73594 <input checked="" type="checkbox"/>	serie 2 pz.	573905	35
125 X 7 Euro 3 (08/09)	09.74400 <input checked="" type="checkbox"/>	set 2 cilindretti	654373	35
125 Zip 4T (00/>)	09.73594 <input checked="" type="checkbox"/>	serie 2 pz.	573512	35
150 Hexagon 2T (94/97)	25.0071 <input type="checkbox"/>	serie 3 pz.	296881	34
150 Fly Euro 3 (08/11 - s/immobilizer)	09.73594 <input checked="" type="checkbox"/>	serie 2 pz.	573512	35
150 Liberty (01/02 - s/immobilizer)	09.73594 <input checked="" type="checkbox"/>	serie 2 pz.	573512	35
150 Liberty (09/11 - s/immobilizer)	09.73594 <input checked="" type="checkbox"/>	serie 2 pz.	573512	35
150 Skipper 2T (94/97)	25.00132 <input type="checkbox"/>	set 3 cilindretti	179292	33
	09.700132 <input checked="" type="checkbox"/>	set 3 cilindretti	179292	33

Marca, c.c., modello, anno	Cod. SGR	Composizione	Riferimento originale	Fig. pag.
150 Skipper 2T (94/97)	<b>25.0014</b> □	1 cilindretto	196486	33
150 Skipper LX 2T (98/99)	<b>09.74401</b> ●	set 3 cilindretti	575124	35
150 Skipper ST 4T (00/02)	<b>09.74401</b> ●	set 3 cilindretti	575124	35
150 Vespa S/IE/College (07/11 - s/immobilizer)	<b>09.73594</b> ●	serie 2 pz.	573905	35
180 Hexagon LXT 2T (98/99)	<b>09.73613</b> ●	serie 3 pz.	575123	35
200 Carnaby (07/10)	<b>09.74400</b> ●	set 2 cilindretti	654373	35
250 Carnaby (07/10)	<b>09.74400</b> ●	set 2 cilindretti	654373	35
250 Hexagon GT/GTX (98/00)	<b>09.73613</b> ●	serie 3 pz.	575123	35
250 X 7 Euro 3 (08/09)	<b>09.74400</b> ●	set 2 cilindretti	654373	35

## PIAGGIO CICLOMOTORI

50 Boxer 1/2 (70/82)	<b>25.0004</b> □	bloccasterzo Zadi	139330	32
50 Boxer 1/2 (70/82)	<b>25.2004</b> ●	bloccasterzo tipo Neimann	155226/120328	32
50 Boss (88/89)	<b>25.0004</b> □	bloccasterzo Zadi	139330	32
50 Bravo TM/EM/EML/EVL/R2 (73/81)	<b>25.0004</b> □	bloccasterzo Zadi	139330	32
50 Bravo TM/EM/EML/EVL/R2 (73/81)	<b>25.2004</b> ●	bloccasterzo tipo Neimann	155226/120328	32
50 Bravo P/PV (81/>)	<b>25.0004</b> □	bloccasterzo Zadi	139330	32
50 Bravo P/PV (81/>)	<b>25.2004</b> ●	bloccasterzo tipo Neimann	155226/120328	32
50 Bravo 3 (87/90)	<b>25.0004</b> □	bloccasterzo Zadi	139330	32
50 Ciao S/R/L/SC/Arc./R2 (69/81)	<b>25.0004</b> □	bloccasterzo Zadi	139330	32
50 Ciao S/R/L/SC/Arc./R2 (69/81)	<b>25.2004</b> ●	bloccasterzo tipo Neimann	155226/120328	32
50 Ciao P/PV/PX/PXV (80/88)	<b>25.0004</b> □	bloccasterzo Zadi	139330	32
50 Ciao P/PV/PX/PXV (80/88)	<b>25.2004</b> ●	bloccasterzo tipo Neimann	155226/120328	32
50 Grillo (89/93)	<b>25.0004</b> □	bloccasterzo Zadi	139330	32
50 Puch P1 Tre	<b>25.0037</b> □ <b>09.70037</b> ●	bloccasterzo-sella bloccasterzo-sella	2577032/573785 2577032/573785	33 33
50 SI' (79/88)	<b>25.2004</b> ●	bloccasterzo tipo Neimann	155226/120328	32
50 SI' FL2 (91/97)	<b>25.0004</b> □	bloccasterzo Zadi	139330	32
50 Super Bravo (85/90)	<b>25.2004</b> ●	bloccasterzo tipo Neimann	155226/120328	32
50 Super Bravo 3 (87/90)	<b>25.0004</b> □	bloccasterzo Zadi	139330	32

## PIAGGIO VESPA - COSA

50 Vespa/N (63/68 - V5A1 <236000)	<b>25.2004</b> ●	bloccasterzo tipo Neimann	070603/120328	32
50 Vespa (68/71 - V5A1 236001<283299)	<b>25.2002</b> ●	bloccasterzo tipo Neimann	152096	32
50 Vespa L (66/68 - V5A1 500001<580000)	<b>25.2004</b> ●	bloccasterzo tipo Neimann	070603/120328	32
50 Vespa L (68/70 - V5A1 580001/>)	<b>25.2002</b> ●	bloccasterzo tipo Neimann	152096	32
50 Vespa R (70/78 - V5A1 700001<912782)	<b>25.2002</b> ●	bloccasterzo tipo Neimann	152096	32
50 Vespa R (78/83 - V5A1 912783/>)	<b>25.0002</b> □	bloccasterzo Zadi	139371	32
50 Vespa/N/L/R (63/83 - V5A1 Export)	<b>25.0072</b> □	serie 2 pz.	256937/256965	35
50 Vespa/L/R (63/83)	<b>25.2006</b> ●	sportello lato motore		34
50 Vespa Elestart (69/76)	<b>25.2002</b> ●	bloccasterzo tipo Neimann	152096	32
50 Vespa S (63/68 - V5SA1 <34200)	<b>25.2004</b> ●	bloccasterzo tipo Neimann	070603/120328	32
50 Vespa S (68/82 - V5SA1 34201/>)	<b>25.2002</b> ●	bloccasterzo tipo Neimann	152096	32
50 Vespa S (78/82 - V5SA1 77868/>)	<b>25.0002</b> □	bloccasterzo Zadi	139371	32
50 Vespa Super Sprint (65/71 - V5SS1)	<b>25.2004</b> ●	bloccasterzo tipo Neimann	070603/120328	32
50 Vespa Sprinter (71/73 - V5SS2)	<b>25.2002</b> ●	bloccasterzo tipo Neimann	152096	32
50 Vespa Special (69/83 - V5A2/V5B1/V5B3)	<b>25.2002</b> ●	bloccasterzo tipo Neimann	152096	32
50 Vespa Special (78/83 - V5B3 207317/>)	<b>25.0002</b> □	bloccasterzo Zadi	139371	32

Marca, c.c., modello, anno	Cod. SGR	Composizione	Riferimento originale	Fig. pag.
50 Vespa Elestart/Special/Sprinter/S/SS	<b>25.2006</b> ●	sportello lato motore		34
50 Vespa PK/S/SS (82/85)	<b>25.00132</b> □ <b>09.700132</b> ●	set 3 cilindretti set 3 cilindretti	179292 179292	33 33
50 Vespa PK/S/SS (82/85)	<b>25.0014</b> □	1 cilindretto	196486	33
50 Vespa PK S Automatica (84/89)	<b>25.0014</b> □	1 cilindretto	196486	33
50 Vespa PK XL/Plurimatic/Rush/N (85/90)	<b>25.00132</b> □ <b>09.700132</b> ●	set 3 cilindretti set 3 cilindretti	179292 179292	33 33
50 Vespa PK XL/Plurimatic/Rush/N (85/90)	<b>25.0014</b> □	1 cilindretto	196486	33
50 Vespa PK XL/Plurimatic/Rush/N (85/90)	<b>09.70006</b> ●	bauletto	198560	34
50 Vespa PK FL/FL2 (90/97 - V5N1/V5N2)	<b>25.0036</b> □	serie 3 pz.	265828	33
50 Vespa PK FL2 Automatica (90/91 - V5P2)	<b>25.0036</b> □	serie 3 pz.	265828	33
50 Vespa PK FL/FL2/Automatica (90/97)	<b>25.0014</b> □	cilindretto bloccasterzo	196486	33
90 Vespa Super Sprint (65/71 - V9SS1)	<b>25.2004</b> ●	bloccasterzo tipo Neimann	070603/120328	32
90 Vespa Racer (71/73 - V9SS2)	<b>25.2002</b> ●	bloccasterzo tipo Neimann	152096	32
90 Vespa/Super Sprint/Racer	<b>25.2006</b> ●	sportello lato motore		34
125/150 Cosa CL/CLX (88/91)	<b>25.00132</b> □ <b>09.700132</b> ●	set 3 cilindretti set 3 cilindretti	179292 179292	33 33
125/150 Cosa CL/CLX (88/91)	<b>25.0014</b> □	1 cilindretto	196486	33
125/150 Cosa 2 (91/97)	<b>25.0014</b> □	1 cilindretto	196486	33
125 Vespa (65/67 - VMA1)	<b>25.2004</b> ●	bloccasterzo tipo Neimann	070603/120328	32
125 Vespa ET3 (76/83 - VMB1)	<b>25.2002</b> ●	bloccasterzo tipo Neimann	152096	32
125 Vespa ET3 (78/83 - VMB1 44966/>)	<b>25.0002</b> □	bloccasterzo Zadi	139371	32
125 Vespa ET3 (76/83)	<b>25.2006</b> ●	sportello lato motore		34
125 Vespa ET3 (76/83)	<b>02.7938</b> ●	quadretto avviamento	160743/159177	37
125 Vespa GT (66/68 - VNL2 30001<62684)	<b>25.2004</b> ●	bloccasterzo tipo Neimann	070603/120328	32
125 Vespa GT (68/73 - VNL2 62685/>)	<b>25.2002</b> ●	bloccasterzo tipo Neimann	152096	32
125 Vespa GTR (69/78 - VNL2 100001/>)	<b>25.2002</b> ●	bloccasterzo tipo Neimann	152096	32
125 Vespa GT/GTR (66/78)	<b>25.0006</b> □	sportello attrezzi	073258/139379	34
125 Vespa P ETS (84/>)	<b>25.0014</b> □	1 cilindretto	196486	33
125 Vespa Primavera (67/68 - VMA2 <028959)	<b>25.2004</b> ●	bloccasterzo tipo Neimann	070603/120328	32
125 Vespa Primavera (68/83 - VMA2 028960/>)	<b>25.2002</b> ●	bloccasterzo tipo Neimann	152096	32
125 Vespa Primavera (78/83 - VMA2 0188997/>)	<b>25.0002</b> □	bloccasterzo Zadi	139371	32
125 Vespa Primavera (65/67)	<b>25.2006</b> ●	sportello lato motore		34
125 Vespa Primavera (65/67)	<b>25.0006</b> □	sportello attrezzi	073258/139379	34
125 Vespa PK/S (82/85)	<b>25.00132</b> □ <b>09.700132</b> ●	set 3 cilindretti set 3 cilindretti	179292 179292	33 33
125 Vespa PK/S (82/85)	<b>25.0014</b> □	1 cilindretto	196486	33
125 Vespa PK S Automatica (84/89)	<b>25.0014</b> □	1 cilindretto	196486	33
125 Vespa PK XL (86/89)	<b>25.00132</b> □ <b>09.700132</b> ●	set 3 cilindretti set 3 cilindretti	179292 179292	33 33
125 Vespa PK XL (86/89)	<b>25.0014</b> □	1 cilindretto	196486	33
125 Vespa PK XL (86/89)	<b>09.70006</b> ●	bauletto	576998	34
125 Vespa PK FL/FL2 (89/91 - VMX7)	<b>25.0036</b> □	serie 3 pz.	265828	33
125 Vespa PK FL/FL2 (89/91 - VMX7)	<b>25.0014</b> □	cilindretto bloccasterzo	196486	33
125/150 Vespa P-X/PX-E (77/82)	<b>02.7938</b> ●	quadretto avviamento	160743/159177	38
125/150 Vespa P-X/PX-E (77/82)	<b>25.2002</b> ●	bloccasterzo tipo Neimann	152096	32
125/150 Vespa P-X/PX-E (77/82)	<b>25.0002</b> □	bloccasterzo Zadi	139371	32
125/150 Vespa P-X/PX-E (77/82)	<b>25.0021</b> ●	2 pz.: blocc. Neimann-bauletto	114431/139188	32
125/150 Vespa P-X/PX-E (77/82)	<b>25.0022</b> ●	3 pz.: blocc. Neimann-baul.-sella	184860	32

Marca, c.c., modello, anno	Cod. SGR	Composizione	Riferimento originale	Fig. pag.
125/150 Vespa P-X/PX-E (77/82)	25.0020 <input type="checkbox"/>	3 pz.: blocc. Zadi-bauletto-sella	190012	32
125/150 Vespa P-X/PX-E (77/82)	25.0006 <input type="checkbox"/>	bauletto	073258/139379	34
125/150 Vespa PX-E/Arcobaleno (83/97)	25.00132 <input type="checkbox"/>	set 3 cilindretti	179292	33
	09.700132 <input checked="" type="checkbox"/>	set 3 cilindretti	179292	33
125/150 Vespa PX-E/Arcobaleno (83/97)	25.0014 <input type="checkbox"/>	1 cilindretto	196486	33
125/150 Vespa PX-E/Arcobaleno (83/97)	09.70006 <input checked="" type="checkbox"/>	bauletto	198560	34
125/150 Vespa PX (98/01)	25.00132 <input type="checkbox"/>	set 3 cilindretti	179292	33
	09.700132 <input checked="" type="checkbox"/>	set 3 cilindretti	179292	33
125/150 Vespa PX (98/01)	25.0014 <input type="checkbox"/>	1 cilindretto	196486	33
125/150 Vespa PX (98/01)	09.70006 <input checked="" type="checkbox"/>	bauletto	198560	34
125 Vespa PX Euro 2 (01/07)	25.00132 <input type="checkbox"/>	set 3 cilindretti	179292	33
	09.700132 <input checked="" type="checkbox"/>	set 3 cilindretti	179292	33
125 Vespa PX Euro 2 (01/07)	25.0014 <input type="checkbox"/>	1 cilindretto	196486	33
125 Vespa PX Euro 2 (01/07)	09.70006 <input checked="" type="checkbox"/>	bauletto	576998	34
125 Vespa PX 30 Anni (07/08)	25.00132 <input type="checkbox"/>	set 3 cilindretti	179292	33
	09.700132 <input checked="" type="checkbox"/>	set 3 cilindretti	179292	33
125 Vespa PX 30 Anni (07/08)	09.70006 <input checked="" type="checkbox"/>	bauletto	576998	34
125/150 Vespa PX (11)	25.00132 <input type="checkbox"/>	set 3 cilindretti	179292	33
	09.700132 <input checked="" type="checkbox"/>	set 3 cilindretti	179292	33
125/150 Vespa PX (11)	09.70006 <input checked="" type="checkbox"/>	bauletto	576998	34
125 Vespa PX T5 (85/89)	25.00132 <input type="checkbox"/>	set 3 cilindretti	179292	33
	09.700132 <input checked="" type="checkbox"/>	set 3 cilindretti	179292	33
125 Vespa PX T5 (85/89)	25.0014 <input type="checkbox"/>	1 cilindretto	196486	33
125 Vespa PX T5 (85/89)	09.70006 <input checked="" type="checkbox"/>	bauletto	198560	34
125 Vespa Super (66/68 - VNC1)	25.2004 <input checked="" type="checkbox"/>	bloccasterzo tipo Neimann	070603/120328	32
125 Vespa TS (75/78 - VNL3)	25.2002 <input checked="" type="checkbox"/>	bloccasterzo tipo Neimann	152096	32
150 Vespa P-S (78/84 - VBX)	02.7938 <input checked="" type="checkbox"/>	quadretto avviamento	160743/159177	37
150 Vespa P-S (78/84 - VBX)	25.2002 <input checked="" type="checkbox"/>	bloccasterzo tipo Neimann	152096	32
150 Vespa P-S (78/84 - VBX)	25.0002 <input type="checkbox"/>	bloccasterzo Zadi	139371	32
150 Vespa P-S (78/84 - VBX)	25.0021 <input checked="" type="checkbox"/>	2 pz.: blocc. Neimann-bauletto	114431/139188	32
150 Vespa P-S (78/84 - VBX)	25.0022 <input checked="" type="checkbox"/>	3 pz.: blocc. Neimann-baul.-sella	184860	32
150 Vespa P-S (78/84 - VBX)	25.0020 <input type="checkbox"/>	3 pz.: blocc. Zadi-bauletto-sella	190012	32
150 Vespa P-S (78/84 - VBX)	25.0006 <input type="checkbox"/>	bauletto	073258/139379	34
150 Vespa Super (66/68 - VBC1 </73779)	25.2004 <input checked="" type="checkbox"/>	bloccasterzo tipo Neimann	070603/120328	32
150 Vespa Super (68/79 - VBC1 73780/>)	25.2002 <input checked="" type="checkbox"/>	bloccasterzo tipo Neimann	152096	32
150 Vespa Super (66/79 - VBC1)	25.0006 <input type="checkbox"/>	sportello attrezzi	073258/139379	34
150 Vespa Sprint (65/68 - VLB1 </077174)	25.2004 <input checked="" type="checkbox"/>	bloccasterzo tipo Neimann	070603/120328	32
150 Vespa Sprint (68/74 - VLB1 077175/>)	25.2002 <input checked="" type="checkbox"/>	bloccasterzo tipo Neimann	152096	32
150 Vespa Sprint (65/74 - VLB1 025479/>)	25.0006 <input type="checkbox"/>	sportello attrezzi	073258/139379	34
150 Vespa Sprint Veloce (69/79)	25.2002 <input checked="" type="checkbox"/>	bloccasterzo tipo Neimann	152096	32
150 Vespa Sprint Veloce (69/79)	25.0006 <input type="checkbox"/>	sportello attrezzi	073258/139379	34
160 Vespa GS II serie (64 - VSB1 005507/>)	25.2004 <input checked="" type="checkbox"/>	bloccasterzo tipo Neimann	070603/120328	32
160 Vespa GS II serie (64 - VSB1 005507/>)	25.0006 <input type="checkbox"/>	bauletto	073258/139379	34
180 Vespa SS (64/68 - VSC1)	25.2004 <input checked="" type="checkbox"/>	bloccasterzo tipo Neimann	070603/120328	32
180 Vespa SS (64/68 - VSC1)	25.0006 <input type="checkbox"/>	bauletto	073258/139379	34
180 Vespa Rally (68/73 - VSD1)	25.2002 <input checked="" type="checkbox"/>	bloccasterzo tipo Neimann	152096	32
180 Vespa Rally (68/73 - VSD1)	25.0006 <input type="checkbox"/>	bauletto	073258/139379	34
200 Cosa CL/CLX (88/91)	25.00132 <input type="checkbox"/>	set 3 cilindretti	179292	33
	09.700132 <input checked="" type="checkbox"/>	set 3 cilindretti	179292	33
200 Cosa CL/CLX (88/91)	25.0014 <input type="checkbox"/>	1 cilindretto	196486	33

Marca, c.c., modello, anno	Cod. SGR	Composizione	Riferimento originale	Fig. pag.
200 Cosa 2 (91/97)	<b>25.0014</b> □	1 cilindretto	196486	33
200 Vespa P-E/PX-E (77/82)	<b>02.7938</b> ●	quadretto avviamento	160743/159177	37
200 Vespa P-E/PX-E (77/82)	<b>25.2002</b> ●	bloccasterzo tipo Neimann	152096	32
200 Vespa P-E/PX-E (77/82)	<b>25.0002</b> □	bloccasterzo Zadi	139371	32
200 Vespa P-E/PX-E (77/82)	<b>25.0021</b> ●	2 pz.: blocc. Neimann-bauletto	114431/139188	32
200 Vespa P-E/PX-E (77/82)	<b>25.0022</b> ●	3 pz.: blocc. Neimann-baul.-sella	184860	32
200 Vespa P-E/PX-E (77/82)	<b>25.0020</b> □	3 pz.: blocc. Zadi-bauletto-sella	190012	32
200 Vespa P-E/PX-E (77/82)	<b>25.0006</b> □	bauletto	073258/139379	34
200 Vespa PX-E/Arcobaleno (83/97)	<b>25.00132</b> □	set 3 cilindretti	179292	33
	<b>09.700132</b> ●	set 3 cilindretti	179292	33
200 Vespa PX-E/Arcobaleno (83/97)	<b>25.0014</b> □	1 cilindretto	196486	33
200 Vespa PX-E/Arcobaleno (83/97)	<b>09.70006</b> ●	bauletto	198560	34
200 Vespa PX (98/01)	<b>25.00132</b> □	set 3 cilindretti	179292	33
	<b>09.700132</b> ●	set 3 cilindretti	179292	33
200 Vespa PX (98/01)	<b>25.0014</b> □	1 cilindretto	196486	33
200 Vespa PX (98/01)	<b>09.70006</b> ●	bauletto	198560	34
200 Vespa PX Euro 2 (01/06)	<b>25.00132</b> □	set 3 cilindretti	179292	33
	<b>09.700132</b> ●	set 3 cilindretti	179292	33
200 Vespa PX Euro 2 (01/06)	<b>25.0014</b> □	1 cilindretto	196486	33
200 Vespa PX Euro 2 (01/06)	<b>09.70006</b> ●	bauletto	576998	34
200 Vespa Rally (72/79)	<b>25.2002</b> ●	bloccasterzo tipo Neimann	152096	32
200 Vespa Rally (72/79)	<b>25.0006</b> □	bauletto	073258/139379	34
200 Vespa Rally (74/79 - VSE1 0018101/>)	<b>02.7938</b> ●	quadretto avviamento	160743/159177	37







## PIAGGIO APE

50 Ape/P/TM P (69/89)	<b>25.2002</b> ●	bloccasterzo tipo Neimann	152096	32
50 Ape FL/FL2/FL3 Europa (89/99)	<b>25.0038</b> □	bloccasterzo-portiera	258664	34
125 Ape 250 (70/74)	<b>25.2002</b> ●	bloccasterzo tipo Neimann	152096	32
125 Ape 350 Avviamento Elettr. (65/71)	<b>09.5355</b> □	quadretto avviamento	100884	37
150/175 Ape 400/R/P 401 Avv. El. (67/81)	<b>09.5355</b> □	quadretto avviamento	100884	37
175 Ape 500 Avv. El. (67/74)	<b>09.5355</b> □	quadretto avviamento	100884	37
190 Ape MP 500 (69/78)	<b>09.5355</b> □	quadretto avviamento	100884	37
190 Ape MP 550 (67/72)	<b>25.2002</b> ●	bloccasterzo tipo Neimann	152096	32
190 Ape MP 550 (67/72)	<b>09.5355</b> □	quadretto avviamento	100884	37
190 Ape MP P501 (78/83)	<b>09.5355</b> □	quadretto avviamento	100884	37
190 Ape MP 600 (70/78)	<b>09.5355</b> □	quadretto avviamento	100884	37
190 Ape MPV 600 (70/78)	<b>25.2002</b> ●	bloccasterzo tipo Neimann	152096	32
190 Ape MPV 600 Elettronico (70/78)	<b>09.8154</b> □	bloccasterzo avviamento	140732	37
190 Ape MP P601V (MPV1 - 78/>)	<b>25.2002</b> ●	bloccasterzo tipo Neimann	152096	32
190 Ape MP P601V Elettron. (MPV1 - 78/>)	<b>09.8154</b> □	bloccasterzo avviamento	140732	37
190 Ape MP P601 (MPM1 - 78/83)	<b>09.8154</b> □	bloccasterzo avviamento	140732	37
220 Ape Car/P2/P3 (72/85)	<b>09.8154</b> □	bloccasterzo avviamento	140732	37
220 Ape MP P601 (MPM2 - 78/96)	<b>09.8154</b> □	bloccasterzo avviamento	140732	37
220 Ape MP P601V (MPV2 - 78/>)	<b>25.2002</b> ●	bloccasterzo tipo Neimann	152096	32
220 Ape MP P601V (MPV2 - 78/>)	<b>09.8154</b> □	bloccasterzo avviamento	140732	37
220 Ape TM P602 (82/83)	<b>09.8154</b> □	bloccasterzo avviamento	140732	37
220 Ape TM P703 (84/00)	<b>09.8154</b> □	bloccasterzo avviamento	140732	37
420 Ape Car Diesel/Max Diesel (86/96)	<b>09.8154</b> □	bloccasterzo avviamento	140732	37
420 Ape TM P703 Diesel (87/00)	<b>09.8154</b> □	bloccasterzo avviamento	140732	37



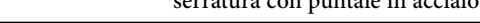

□ Di primo equipaggiamento

● Adattabile







## Serrature di primo equipaggiamento Derbi/Gilera/Piaggio







Cod. SGR	descrizione/applicazione	rif. originale	figura
25.0020	<p>tris serrature Zadi (Q143) composta da: serratura bloccasterzo (art. 25.0002)*, serratura bauletto (25.0006), cilindretto serratura sella</p> <p><u>Di primo equipaggiamento su:</u> <b>Piaggio</b> Vespa P 125/150 X • P 150 S • P 200 E</p>	190012	
25.0021	<p>coppia serrature tipo Neiman (Zadi Q145) composta da: serratura bloccasterzo (art. 25.2002)*, serratura bauletto (25.0006)</p> <p><u>Adattabile su:</u> <b>Piaggio</b> Vespa P 125/150 X • P 150 S • P 200 E</p>	139188/114431	
25.0022	<p>tris serrature tipo Neiman (Zadi Q144) composta da: serratura bloccasterzo (art. 25.2002)*, serratura bauletto (25.0006) cilindretto serratura sella</p> <p><u>Adattabile su:</u> <b>Piaggio</b> Vespa P 125/150 X • P 150 S • P 200 E</p>	184860	 <p>*serratura con puntale in acciaio</p>
25.0004	<p>serratura bloccasterzo Zadi con chiavi (Q20/01)</p> <p><u>Di primo equipaggiamento su:</u> <b>Gilera</b> GSA 50 <b>Piaggio</b> 50 Boxer 1/2 (70/82) • 50 Boss (88/89) 50 Bravo TM/EM/EML/EVL/R2 (73/81) 50 Bravo P/PV (81/&gt;) • 50 Bravo 3 (87/90) • 50 Grillo (89/93) 50 Ciao S/R/L/SC/Arc./R2 (67/81) • 50 Si FL2 (91/97) 50 Ciao P/PV/PX/PXV (80/88) • 50 Super Bravo 3 (87/90)</p>	139330 (139329)	
25.2004	<p>serratura bloccasterzo tipo Neiman con chiavi (Zadi Q20/10)</p> <p><u>Adattabile su:</u> <b>Piaggio</b> 50 Boxer 1/2 (70/82) 50 Bravo TM/EM/EML/EVL/R2 (73/81) 50 Bravo P/PV (81/&gt;) • 50 Ciao S/R/L/SC/Arc./R2 (67/81) 50 Ciao P/PV/PX/PXV (80/88) • 50 Si (79/88) 50 Super Bravo (85/90) • 50 Vespa (63/68) • 50 Vespa L (66/68) 50 Vespa S (63/68) • 50 Vespa Super Sprint (65/71) 90 Vespa/Super Sprint (63/71) • 125 Vespa GT (66/68) 125 Vespa Primavera (67/68) • 125 Vespa Super (66/68) 150 Vespa Super (66/68) • 150 Vespa Sprint (65/68) 160 Vespa GS II Serie (64) • 180 Vespa SS (64/68)</p>	120328 (070603)	
25.0002*	<p>serratura bloccasterzo Zadi con chiavi (Q20/02)</p> <p><u>Di primo equipaggiamento su:</u> <b>Piaggio</b> 50 Vespa R (78/83) • 50 Vespa S (78/82) 50 Vespa Special (78/&gt;) • 125 Vespa ET3 (78/83) 125 Vespa Primavera (78/83) • 125/150 Vespa P-X (77/82) 125/150 Vespa PX-E (81/82) • 150 Vespa P-S (78/&gt;) 200 Vespa P-E (77/82) • 200 Vespa PX-E (82/83)</p>	139371	
25.2002*	<p>serratura bloccasterzo tipo Neiman con chiavi (Zadi Q20/11)</p> <p><u>Adattabile su:</u> <b>Piaggio</b> 50 Vespa (63/71) • 50 Vespa L (66/70) Vespa 50 S (68/82) • 50 Vespa R (70/78) 50 Vespa Elestart (70/76) • 50 Vespa Special (70/83) 50 Vespa Sprinter (71/73) • 90 Vespa Racer (71/73) 125 Vespa ET3 (76/83) • 125 Vespa GT (68/73) 125 Vespa GTR (69/78) • 125 Vespa Primavera (68/83) 125/150 Vespa P-X (77/82) • 125/150 Vespa PX-E (81/82) 125 Vespa TS (75/78) • 150 Vespa P-S (78/&gt;) 150 Vespa Super (68/79) • 150 Vespa Sprint (68/74) 150 Vespa Sprint Veloce (69/79) • 180 Vespa Rally (68/73) 200 Vespa P-E (77/82) • 200 Vespa PX-E (82/83) 200 Vespa Rally (72/79) • 50 Ape/P/TM P (69/89) 125 Ape 250 (70/74) • 190 Ape MP 550 (67/72) 190 Ape MPV 600 (70/78) 190 Ape MP P601V (MPV1 - 78/&gt;) 220 Ape MP P601V (MPV2 - 78/&gt;)</p>	152096	 <p>*serratura con puntale in acciaio</p>



Cod. SGR	descrizione/applicazione	rif. originale	figura
<b>25.00132</b> <b>09.700132</b>	set serrature Zadi (serie 3 cilindretti - Q262) con chiavi set serrature adattabile (serie 3 cilindretti) con chiavi  <u>Di primo equipaggiamento su:</u> <b>Gilera</b> 50 Storm (94/95) • 50 Typhoon/X/XR (94/00) 125 Typhoon/X/XR (95/00) <b>Piaggio</b> 50 Free (92/94) • 50 NRG (94/96) 50 Quartz (92/96) • 50 Sfera/Maquillage 2/FL Rst (91/97) 50 Typhoon (01/04) • 125 Sfera FL (95/97) 125 Skipper 2T (94/97) • 150 Skipper 2T (94/97) 50 Vespa PK/S/SS (82/85) 50 Vespa PK XL/Plurimatic/Rush/N (85/90) 125/150 Cosa CL/CLX (88/91) • 125 Vespa PK/S (82/85) 125 Vespa PK XL (86/89) 125/150 Vespa PX-E/Arcobaleno (83/97) 125/150 Vespa PX (98/01) • 125 Vespa PX Euro 2 (01/07) Vespa PX 125/150 (11) • Vespa PX 125 30 anni (07/08) 125 Vespa PX T5 (85/89) • 200 Cosa CL/CLX (88/91) 200 Vespa PX-E/Arcobaleno (83/97) • 200 Vespa PX (98/01) 200 Vespa PX Euro 2 (01/06)	179292	
<b>25.0014</b>	cilindretto singolo Zadi di ricambio (Q154) con chiavi  <u>Di primo equipaggiamento su:</u> <b>Gilera</b> 50 Storm (94/95) • 50 Typhoon/X/XR (94/00) 125 Typhoon/X/XR (95/00) <b>Piaggio</b> 50 Free (92/94) • 50 NRG (94/96) 50 Quartz (92/96) • 50 Scatto (92/93) 50 Sfera/Maquillage 2/FL Rst (91/97) 50 Typhoon (01/04) • 125 Sfera FL (95/97) 125 Skipper 2T (94/97) • 150 Skipper 2T (94/97) 50 Vespa PK/S/SS (82/85) 50 Vespa PK S Automatica (84/89) 50 Vespa PK XL/Plurimatic/Rush/N (85/90) 50 Vespa PK FL/FL2 (90/97) 125/150 Cosa CL/CLX (88/91) • 125/150 Cosa 2 (91/97) 125 Vespa P ETS (84/>) • 125 Vespa PK/S (82/85) 125 Vespa PK S Automatica (84/89) 125 Vespa PK XL (86/89) 125/150 Vespa PX-E/Arcobaleno (83/97) 125/150 Vespa PX (98/01) • 125 Vespa PX Euro 2 (01/06) 125 Vespa PX T5 (85/89) 200 Cosa CL/CLX (88/91) • 200 Cosa 2 (91/97) 200 Vespa PX-E/Arcobaleno (83/97) 200 Vespa PX (98/01) • 200 Vespa PX Euro 2 (01/06)	196486	
<b>25.0036</b>	set serrature Zadi (serie 3 pezzi - Q583) con chiavi: bloccasterzo, sella, bauletto  <u>Di primo equipaggiamento su:</u> <b>Piaggio</b> Vespa PK 50 FL2 Automatica (90/91) Vespa PK 50 FL/FL2 HP (91/97) Vespa PK 125 FL (89/90)	265828	
<b>25.0037</b> <b>09.70037</b>	set serrature Zadi (serie 2 pezzi - bloccasterzo, sella - Q729) con chiavi set serrature adattabile (serie 2 pezzi - bloccasterzo, sella) c/chiavi  <u>Di primo equipaggiamento su:</u> <b>Gilera</b> 50 Stalker (97/10) • 50 Stalker Naked/S.E. (07/08) 50 Storm Euro 2 (07/08) <b>Piaggio</b> 50 Free/FL/Delivery (95/02) • 50 Puch P1-Tre 50 NRG MC <sup>2</sup> /Extreme/MC <sup>3</sup> /Purejet (96/04) 50 NTT (95/96) • 50 Typhoon (05/09) 50 Velofax (96/99) • 100 Free 4T (02/>)	2577032 573785 (440659)	



**34 Serrature di primo equipaggiamento Derbi/Gilera/Piaggio**

Cod. SGR	descrizione/applicazione	rif. originale	figura
<b>25.0038</b>	set serrature Zadi (serie 2 pezzi - bloccasterzo, portiera - Q739) con chiavi <u>Di primo equipaggiamento su:</u> <b>Piaggio</b> Ape 50 FL/FL2/FL3 Europa (89/99)	258664	
<b>25.0039</b>	set serrature Zadi (serie 3 pezzi - bloccasterzo, sella, bauletto ant. Q825) con chiavi <u>Di primo equipaggiamento su:</u> <b>Gilera</b> 50 Easy Moving (95/96) <b>Piaggio</b> 50 Zip Base/Rst (92/99) 50 Zip Fast Rider/Rst (93/97) 50 Zip & Zip Bimodale (94/97) 50 Zip SP (96/00)	295652	
<b>25.0006</b>	serratura bauletto, sportello portaoggetti Zadi (Q28/01) con chiavi <u>Di primo equipaggiamento su bauletto anteriore:</u> <b>Piaggio</b> 125/150 Vespa P-X (77/82) 125/150 Vespa PX-E (81/82) • 150 Vespa P-S (78/>) 160 GS II Serie (64) • 180 Vespa Rally (68/73) 200 Vespa P-E (77/82) • 200 Vespa PX-E (82/83) 200 Vespa Rally (72/79) <u>Di primo equipaggiamento su portaoggetti sportello laterale:</u> <b>Piaggio</b> Vespa 125/150 Super • 150 Sprint/Veloce 125 Vespa GT/GTR • 125 Vespa Primavera/ET3	073258/ 139379	
<b>09.70006</b>	serratura bauletto nera con chiavi <u>Adattabile su:</u> <b>Piaggio</b> 50 Vespa PK XL/Plurimatic/Rusch/N (85/90) 125 Vespa PK XL (86/89) 125/150 Vespa PX-E/Arcobaleno (83/97) 125/150 Vespa PX (98/01) • 125 Vespa PX Euro 2 (01/07) Vespa PX 125 30 anni (07/08) • Vespa PX 125/150 (11) 125 Vespa PX T5 (85/89) 200 Vespa PX-E/Arcobaleno (83/97) 200 Vespa PX (98/01) • 200 Vespa PX Euro 2 (01/06)	576998/198560 214945	
<b>25.2006</b>	serratura Zadi con chiavi (Q22/10) (completa di piastra blocca serratura) <u>Adattabile per cofano lato motore su:</u> <b>Piaggio</b> Vespa 50/90 • 125 Primavera • 125 ET3 <u>Di primo equipaggiamento per serratura sella su:</u> <b>Gilera</b> Bullit 50	324311	
<b>25.0071</b>	set serrature Zadi (serie 3 pezzi - Q953/1) con chiavi <u>Di primo equipaggiamento su:</u> <b>Piaggio</b> Hexagon 125/150 2T (94/97)	296881	

Cod. SGR	descrizione/applicazione	rif. originale	figura
25.0072	set serrature Zadi (serie 2 pezzi - Q1481) con chiavi  <u>Di primo equipaggiamento su:</u> <b>Piaggio</b> Vespa 50/L/R (63/83 - <u>estero</u> )	256937/ 256965	
25.0073	set serrature Zadi (serie 3 pezzi - bloccasterzo, sella, bauletto post. - Q1155) con chiavi  <u>Di primo equipaggiamento su:</u> <b>Piaggio</b> Free 50 FL/Delivery (95/02) Sfera 50 FL RST (95/97 - <u>Olanda</u> )	298786 (299261) (298362)	
09.73594	set serrature adattabile (serie 2 pezzi - bloccasterzo, sella) con chiavi  <u>Adattabile su:</u> <b>Gilera</b> 50 Ice (01/05) • 50 Runner/Poggiali/SP (97/04) 50 Runner Purejet (02/04) • 125 Runner FX 2T (97/02) 180 Runner FXR 2T (97/02) <b>Piaggio</b> 50 Fly 2T/4T (05/10) 50 Liberty 2T/4T/Rst/PPTT/Sport/MOC/Elle (97/10) 50 Vespa ET2 (97/05) • Vespa 50 S 2T/4T-4V (07/10) 50 Vespa ET4 (00/05) 50 Vespa LX/LXV 2T/4T/4T-4V/Touring (05/11) 50 Zip SP (01/10) • 50 Zip Cat. 2T (00/10) 50 Zip 4T (00/10) • 100 Fly 4T (06/07) • 100 Zip 4T (06/10) 125 Liberty (98/02) • 125 Liberty (09/10) 125 Vespa ET4 (96/98) • Vespa S 125/150/IE (07/10) 125 Zip 4T (00/>) • 125/150 Fly Euro 3 (07/10) 150 Liberty (01/02) • Liberty 150 (09/10)	576718/573512 573905	
09.73613	set serrature adattabile (serie 3 pezzi) con chiavi  <u>Adattabile su:</u> <b>Piaggio</b> Hexagon LX 125 2T (98/99) Hexagon LX4 125 4T (98/99) Hexagon LXT 180 2T (98/99) Hexagon GT/GTX 250 (98/00)	575123	
09.74400	set serrature adattabile (serie 2 pezzi) con chiavi  <u>Adattabile su:</u> <b>Piaggio</b> X7 125/250 Euro 3 (08/09) Carnaby 125/200/250 (07/10)	654373	
09.74401	set serrature adattabile (serie 3 pezzi) con chiavi  <u>Adattabile su:</u> <b>Derbi</b> Boulevard 125/150 Euro 3 (02/07) Boulevard 200 (05) <b>Piaggio</b> Skipper 125/150 LX/ST (98/02)	575124	

Cod. SGR	descrizione/applicazione	rif. originale	figura
25.0026	coperchio serratura Zadi (TR/44) in acciaio - s/rivetto <u>Adattabile su:</u> <b>Piaggio</b> ciclomotori Ciao • Ciao PX • Sì • Bravo Bravo EVL • SuperBravo • Grillo • Boss	139369	

## Serrature bloccasterzo moto e ciclomotori vari

Cod. SGR	descrizione/applicazione	rif. originale	figura
25.0002*	serratura bloccasterzo Zadi (Q20/Q2) con chiavi <u>Di primo equipaggiamento su:</u> <b>Aprilia</b> 125 ST  <u>Adattabile su:</u> <b>moto e ciclomotori vari</b>		
25.2002*	serratura bloccasterzo tipo Neiman con chiavi (Zadi Q20/11) <u>Adattabile su:</u> <b>moto stradali/enduro • ciclomotori vari</b>		 *serratura con puntale in acciaio

## Blocchetti avviamento con chiave

**02.7911** in plastica nera - Ø 29,5 - 2 posizioni - 3 faston - chiave nuda c/ghiera di metallo cromata (elettricamente uguale al **02.7971**)



Adattabile su:

**Ducati** 250/350/450 Scrambler (68/72 - acc. puntine)  
250/350/450 Mark 3/Desmo (acc. puntine)  
750 GT/Sport (73/75 - s/avv.to elettrico) • 750/900 SS Desmo (75)

**Gilera**

Rif. **Ducati**: 068738320

**02.7971** in plastica nera - Ø 29,5 - 2 posizioni - 3 faston orizzontali - chiave nuda c/ghiera di metallo cromata (elettricamente uguale al **02.7911**)

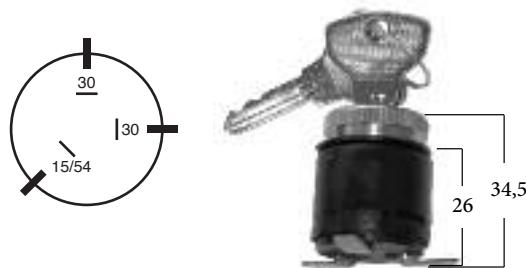

Adattabile su:

**muletto, trattori e applicazioni varie**

**02.7972** Zadi in plastica nera - Ø 28,5 - 3 posizioni - 4 faston - chiave ricoperta - c/ghiera di metallo cromata

Di primo equipaggiamento su:

**Moto Guzzi** Nevada 350/Club (92/99) • NTX 350/650 • 350 V35/II/III • 350 V35 C  
350 V35 Florida • 500 V50/II/III • 500 V50 C • 500 V50 Polizia (82/90) • 650 V65 GT  
650 V65 Lario • 650 V65 Custom/Florida • 650 V65 Polizia (88/95) • Nevada 750/Club (91/01)  
Targa 750 • 750 V75 • 850 Le Mans I/II/III • 850 T3/California/T4/T5 (75/87) • 1000 GT • 1000 S  
1000 SP/II (79/87) • 1000 G5 • 1000 California II (81/87) • 1000 California III Carb./IE (87/93)  
1000 Le Mans (84/93) • V1000 Convert • 1100 California (94/97)

Adattabile su:

**Benelli/Moto Guzzi** 254 • 300 LS • 354 • 500 LS • 504 • 654

Rif. **Benelli/Guzzi**: 65.73.53.00

Rif. **Guzzi**: GU31735360 • GU19735300 • GU19736880 • GU28735360 • GU17735350

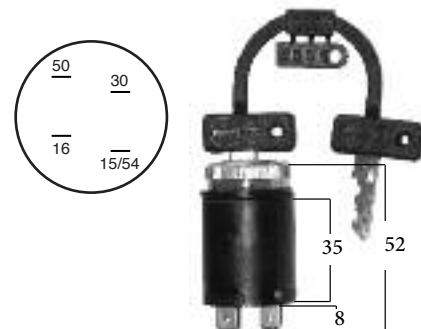

Sostituisce: **02.7927 • 02.7932 • 02.7933**

**02.7973** in plastica nera - Ø 29,5 - 2 posizioni - 2 faston - chiave ricoperta c/ghiera di metallo cromata

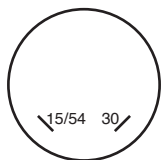

Adattabile su:

**Fiat OM** carrelli

**Ducati** 250/350

**Moto e ciclomotori vari**

**02.79122** in plastica nera - Ø 29,5 - 2 posizioni - 3 faston - chiave ricoperta c/ghiera di metallo cromata - funzionante con chiave disinserita (electricamente opposto al **02.7911** • **02.7971**)

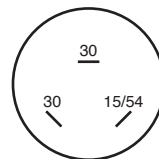

Adattabile su:

**ciclomotori e applicazioni varie**

**02.79131** Zadi in plastica nera - Ø 27,5 - 2 posizioni - 4 faston - chiave ricoperta - c/ghiera di metallo cromata

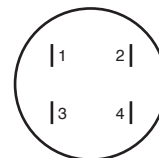

Adattabile su:

**Ducati** 250/350/450 Scrambler/Desmo (acc. elettronica - 72/>)

**Moto Morini** 125

**Malanca** 125 2C

**Sostituisce: 02.7913**

**02.79141** Zadi in plastica nera - Ø 27,5 - 3 posizioni - 6 faston chiave ricoperta - c/ghiera di metallo cromata

posizione	contatti						chiave
	1	2	3	4	5	6	
0	●	●	○	○	○	○	estraibile
1	○	○	○	○	●	●	non estraibile
2	○	○	●	●	●	●	non estraibile

Adattabile (CEV 8205/8224) su:

**Aprilia** ET 50 (84/85) • ETX 50 (86) • Tuareg 50 (85)/125 (86)

**Beta** RX 50 • Beta Four • KR 50

**Ciclomotori Cimatti • Motron • Unimoto**

**Fantic Motor** 50 Raider • 50 Koala • 50 Fast • 50 Oasi

**Garelli** Formuno Raid 88 • Tiger (avv. elettr.)

**Honda** PX/PXR 50 SE • CB 125 Endurance (Italia)

**Laverda** OR 50 Atlas

**Malaguti** 50 MEX/MDX/MGX/MRX • 50 Dune • 50 Fifty/Full CX/Top/HF/RV/UP/Evolution

JX 50 • 125 Runner • 125 Runner Rally (YPVS)

**Yamaha** DT 125/YPVS (Belgarda)

Rif. *Aprilia*: 8212068/8201140

Rif. *Fantic*: 238110051800

Rif. *Honda*: 3510A-197-000

Rif. *Malaguti*: 09002200 • 02001300 • 02000300

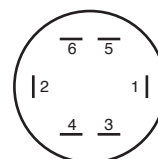

**Sostituisce: 02.7914**

**09.8154** Sipea in metallo c/ghiera di plastica nera - 4 posizioni - 8 faston - chiave nuda c/molla di ritorno avviamento (accensione tipo auto)

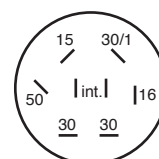

Di primo equipaggiamento su:

**Piaggio** Ape Car/P2/P3 (72/85) • Ape Car Diesel (82/83) • Ape Max Diesel (89/96)

Ape MP P601 (78/96) • Ape TM P602 (82/83) • Ape TM P703 (84/00) • Ape TM P703 Diesel (87/00)

Rif. orig.: 140732

## Quadretti avviamento Piaggio

**02.7938** quadretto avviamento c/chiavi



Adattabile su:

**Piaggio** Vespa 125 ET3 • Vespa P 125/150 X • P 200 E

Vespa PX 125/150/200 E • Vespa P 150 S • Vespa 200 Rally (74/79)

Rif. orig.: 159177 • 160743

**Sostituisce 09.8151**

**09.5355** quadretto avviamento



Di primo equipaggiamento su:

**Piaggio** Ape 350/400/400 R/500 • Ape MP 500/550/600

Ape P401/P501

Rif. orig.: 100884

## Tabella applicazioni commutatori luci e frecce Piaggio Vespa - Ape

Marca, c.c., modello, anno	COMMUTATORI LUCI		Fig. pag.	COMMUTATORE FRECCHE		Fig. pag.
	Cod. SGR	Rif. originale		Cod. SGR	Rif. originale	
<b>VESPA</b>						
Vespa 50/N (63/71 - V5A1 s/luce stop - Italia)	09.4013	☐	092654	42		
Vespa 50/N (63/65 - V5A1 fino a 92876 c/luce stop - estero)	09.37811	●	95463/089471	42		
Vespa 50/N (65/71 - V5A1 da 92877 c/luce stop - estero)	09.7169	☐	073169	42		
Vespa 50 L (66/70 - V5A1 500001/>)	09.4013	☐	092654	42		
Vespa 50 R (69/83 - V5A1 700001/>)	09.4013	☐	092654	42		
Vespa 50 R (69/76 - V5A1 da 700001 a 887476 - Francia)	09.7250	☐	123152	44		
	09.72501	●	123152	44		
Vespa 50 S (63/65 - V5SA1 fino a 13624)	09.37811	●	089471	42		
Vespa 50 S (65/82 - V5SA1 da 13625)	09.7169	☐	073169	42		
Vespa 50 S (63/82 - V5SA1 c/frecce - estero)	09.4013	☐	092654	42	09.61351	● 061350 44
Vespa 50 S (68/82 - V5SA1 da 31001 - USA)	09.4013	☐	092654	42		
Vespa 50 SS Super Sprint (65/71 - V5SS1)	09.7169	☐	073169	42		
Vespa 50 SS Super Sprint (65/71 - V5SS1 c/frecce - estero)	09.4013	☐	092654	42	09.61351	● 061350 44
Vespa 50 Sprinter (71/73 - V5SS2)	09.7169	☐	073169	42		
Vespa 50 Sprinter (71/73 - V5SS2 c/frecce - estero)	09.4013	☐	092654	42	09.61351	● 061350 44
Vespa 50 SR (75/79 - V5SS2 10001/> Germania)	09.4013	☐	092654	42	09.61351	● 061350 44
Vespa 50 Special (69/83 - V5A2/V5B1/V5B3)	09.7250	☐	123152	44		
	09.72501	●	123152	44		
Vespa 50 Special Revival (91 - V5R1)	09.7250	☐	123152	44		
	09.72501	●	123152	44		
Vespa 90 (63/84 - V9A1)	09.3954	☐	092041	42		
	09.39541	●	092041	42		
Vespa 90 (63/74 - V9A1 fino a 109938 c/frecce - c/batteria - estero)	09.4013	☐	092654	42	09.61351	● 061350 44
Vespa 90 SS Super Sprint/Racer (65/73 - V9SS1/V9SS2)	09.3954	☐	092041	42		
	09.39541	●	092041	42		
Vespa 90 SS Super Sprint/Racer (65/73 - V9SS1/V9SS2 c/frecce - estero)	09.4013	☐	092654	42	09.61351	● 061350 44
Vespa 100 (78/84 - V9B1 s/batteria - s/frecce)	09.3954	☐	092041	42		
	09.39541	●	092041	42		
Vespa 100/Sport (78/84 - V9B1 c/batteria - c/frecce - estero/USA)	09.4013	☐	092654	42	09.61351	● 061350 44
Vespa 125 (57/59 - VNA1/VNA2 s/batteria)	09.37811	●	089471	42		
Vespa 125 (59/61 - VNB1 c/batteria)	09.37811	●	26645/089471	42		
Vespa 125 (61/66 - VNB2/VNB6 s/batteria)	09.3954	☐	092041	42		
	09.39541	●	092041	42		
Vespa 125/Primavera (65/83 - VMA1/VMA2 - s/batteria)	09.3954	☐	092041	42		
	09.39541	●	092041	42		
Vespa 125 (65/67 - VMA1 c/frecce - c/batteria - estero/USA)	09.4013	☐	092654	42	09.61351	● 061350 44
Vespa 125 Primavera (67/74 - VMA2 <0126226 c/frecce - estero)	09.4013	☐	092654	42	09.61351	● 061350 44
Vespa 125 ET3 (76/83 - VMB1 s/batteria)	09.3324	☐	143324	42		
Vespa 125 ET3 (76/83 - VMB1 c/frecce - c/batteria - estero)	09.4013	☐	092654	42	09.61351	● 061350 44
Vespa 125 GT/GTR (66/78 - VNL2 s/batteria - s/frecce)	09.3954	☐	092041	42		
	09.39541	●	092041	42		
Vespa 125 GT (66/73 - VNL2 c/batteria - estero/USA)	09.4013	☐	092654	42		
Vespa 125 GTR (69/78 - VNL2 s/batteria - c/frecce)	09.3954	☐	092041	42	09.61351	● 061350 44
	09.39541	●	092041	42		
Vespa 125 GTR (69/78 - VNL2 c/batteria - s/frecce)	09.3781	☐	087558	42		
Vespa 125 GTR (69/78 - VNL2 c/batteria - c/frecce)	09.3781	☐	087558	42	09.61351	● 061350 44
Vespa 125 GTR (69/78 - VNL2 c/fanale Siem)	09.4013	☐	092654	42		
Vespa 125 TS (75/78 - VNL3 s/batteria)	09.3954	☐	092041	42		
	09.39541	●	092041	42		
Vespa 125 TS (75/78 - VNL3 s/batteria)	09.3781	☐	087558	42		
Vespa 125 Super (65/69 - VNC1 s/batteria)	09.3954	☐	092041	42		
	09.39541	●	092041	42		
Vespa 125 Super (65/69 - VNC1 c/batteria - estero)	09.3781	☐	087558	42		

Marca, c.c., modello, anno	COMMUTATORI LUCI		Fig. pag.	COMMUTATORE FRECCHE		Fig. pag.
	Cod. SGR	Rif. originale		Cod. SGR	Rif. originale	
Vespa 150 (57/58 VB1 c/batteria - s/luce stop - Italia)	<b>09.37811</b> ●	089471	42			
Vespa 150 (58/59 - VBA fino a 76050 c/batteria)	<b>09.37811</b> ●	089471	42			
Vespa 150 (59/60 - VBA da 76051 c/batteria)	<b>09.3781</b> □	29865/087558	42			
Vespa 150 (60/62 - VBB1 c/batteria - Italia)	<b>09.3781</b> □	087558	42			
Vespa 150 (62/67 - VBB2 s/batteria - Italia)	<b>09.3954</b> □	092041	42			
	<b>09.39541</b> ●	092041	42			
Vespa 150 GL (57/58 - VGL1 c/batteria - estero)	<b>09.37811</b> ●	089471	42			
Vespa 150 GL (62/65 - VLA1 c/batteria - Italia)	<b>09.3781</b> □	087558	42			
Vespa 150 Super (65/79 - VBC1 s/batteria - s/frecce)	<b>09.3954</b> □	092041	42			
	<b>09.39541</b> ●	092041	42			
Vespa 150 Super (74/79 - VBC1 s/batteria - c/frecce)	<b>09.3954</b> □	092041	42	<b>09.61351</b> ●	061350	44
	<b>09.39541</b> ●	092041	42			
Vespa 150 Super (74/75 - VBC1 </335093 c/batteria - c/frecce)	<b>09.3781</b> □	087558	42	<b>09.61351</b> ●	061350	44
Vespa 150 Super (74/79 - VBC1 c/fanale Siem)	<b>09.4013</b> □	092654	42			
Vespa 150 Sprint (65/74 - VLB1 s/batteria)	<b>09.3954</b> □	092041	42			
	<b>09.39541</b> ●	092041	42			
Vespa 150 Sprint (65/74 - VLB1 c/batteria - estero)	<b>09.3781</b> □	087558	42			
Vespa 150 Sprint Veloce (69/79 - VLB1 s/batteria - s/frecce)	<b>09.3954</b> □	092041	42			
	<b>09.39541</b> ●	092041	42			
Vespa 150 Sprint Veloce (69/79 - VLB1 s/batteria - c/frecce)	<b>09.3954</b> □	092041	42	<b>09.61351</b> ●	061350	44
	<b>09.39541</b> ●	092041	42			
Vespa 150 Sprint Veloce (69/79 - VLB1 c/batteria - s/frecce)	<b>09.3781</b> □	087558	42			
Vespa 150 Sprint Veloce (69/75 - VLB1 c/batteria - c/frecce)	<b>09.3781</b> □	087558	42	<b>09.61351</b> ●	061350	44
Vespa 150 Sprint Veloce (74/79 - VLB1 c/fanale Siem)	<b>09.4013</b> □	092654	42			
Vespa 150 GS (55/61 - VS1/VS5)	<b>09.6457</b> □	026457	42			
Vespa 160 GS (62/64 - VSB1 c/batteria)	<b>09.6457</b> □	026457	42			
Vespa 160 GS (62/64 - VSB1 s/batteria)	<b>09.3954</b> □	092041	42			
	<b>09.39541</b> ●	092041	42			
Vespa 180 SS (64/68 - VSC1 s/batteria)	<b>09.3954</b> □	092041	42			
	<b>09.39541</b> ●	092041	42			
Vespa 180 Rally (68/73 - VSD1 s/batteria )	<b>09.3954</b> □	092041	42			
	<b>09.39541</b> ●	092041	42			
Vespa 180 Rally (68/73 - VSD1 c/batteria - c/frecce - estero)	<b>09.4013</b> □	092654	42	<b>09.61351</b> ●	061350	44
Vespa 200 Rally (72/79 - VSE1 s/batteria - s/frecce)	<b>09.3324</b> □	143324	42			
Vespa 200 Rally (72/79 - VSE1 c/batteria - s/frecce)	<b>09.3680</b> □	143680	42			
Vespa 200 Rally (72/76 - VSE1 fino a 0033996 c/batteria - c/frecce)	<b>09.3680</b> □	143680	42	<b>09.61351</b> ●	061350	44
Vespa 200 Rally (77/79 - VSE1 da 0033997 c/batteria - c/frecce)	<b>09.3680</b> □	143680	42			

## VESPA PX

Vespa 125 P-X (77/82 - VNX1 s/frecce)	<b>09.67521</b> ●	160752	43			
Vespa 125 P-X (77/82 - VNX1 c/frecce - s/batteria)	<b>09.6754</b> □	149185	43	<b>09.6745</b> □	163132	45
	<b>09.67541</b> ●	149185	43	<b>09.67451</b> ●	163132	45
Vespa 125 P-X (77/82 - VNX1 c/frecce - c/batteria)	<b>09.8790</b> □	187900	44	<b>09.4516</b> □	164516	45
Vespa 125 P-X (77/82 - VNX1 Austria)				<b>09.94301</b> ●	162367/219430	44
Vespa 125 PX-E (81/83 - VNX2 s/frecce - impianto 6V)	<b>09.6740</b> □	160740	43			
Vespa 125 PX-E (81/83 - VNX2 s/frecce-s/batteria - impianto 12V)	<b>09.6754</b> □	149185	43			
	<b>09.67541</b> ●	149185	43			
Vespa 125 PX-E (81 - VNX2 fino a 100049 c/frecce - s/batteria)	<b>09.6754</b> □	149185	43	<b>09.6745</b> □	163132	45
	<b>09.67541</b> ●	149185	43	<b>09.67451</b> ●	163132	45
Vespa 125 PX-E (82/83 - VNX2 da 100050 c/frecce - s/batteria)	<b>09.5668</b> □	215668/2156685	43	<b>09.56697</b> ●	215669	45
Vespa 125 PX-E (81/83 - VNX2 c/frecce - c/batteria)	<b>09.8790</b> □	187900	44	<b>09.4516</b> □	164516	45
Vespa 125 PX-E (81/83 - VNX2 Austria)				<b>09.94301</b> ●	188349/219430	45
Vespa 125 PX-E Arcobaleno (83/97 - VNX2 c/frecce - s/batteria)	<b>09.92111</b> ●	217898/232240	44	<b>09.78491</b> ●	215968/580395	45
Vespa 125 PX-E Arcobaleno (84/97 - VNX2 c/frecce - c/avv.to)	<b>09.9430</b> □	218822/231850	44	<b>09.7843</b> □	217343/2318515	45
Vespa 125 PX-E Arcobaleno (83/97 - VNX2 c/batteria - estero)	<b>09.9430</b> □	218822/231850	44	<b>09.7843</b> □	217343/2318515	45
Vespa 125 PX-E Arcobaleno (83/97 - VNX2 s/batteria - Austria)				<b>09.94301</b> ●	219211	45
Vespa 125 PX-E Arcobaleno (84/97 - VNX2 c/avv.to - Austria)				<b>09.94301</b> ●	219430	45

Marca, c.c., modello, anno	COMMUTATORI LUCI		Fig. pag.	COMMUTATORE FRECCHE		Fig. pag.
	Cod. SGR	Rif. originale		Cod. SGR	Rif. originale	
Vespa 125 PX-E (98/01 - VNX2)				<b>09.78491</b> ●	231849/580395	45
Vespa 125 PX Euro 2 (01/06 - M09302)				<b>09.78491</b> ●	231849/580395	45
Vespa 125 PX 30 Anni (07/08 - M09302)				<b>09.78491</b> ●	231849/580395	45
Vespa 125 PX (11)				<b>09.78491</b> ●	231849/580395	45
Vespa 125 PX T5 (85/89 - VNX5 s/avv.to elettrico)				<b>09.78491</b> ●	231849/580395	45
Vespa 125 PX T5 (85/89 - VNX5 c/avv.to elettrico)				<b>09.78491</b> ●	231849/580395	45
Vespa 150 P-S (78/84 - VBX1 s/frecce)	<b>09.67521</b> ●	160752	43			
Vespa 150 P-S (78/84 - VBX1 c/frecce - s/batteria)	<b>09.6754</b> □ <b>09.67541</b> ●	149185 149185	43 43	<b>09.6745</b> □ <b>09.67451</b> ●	163132 163132	45 45
Vespa 150 P-X (78/81 - VLX1 s/frecce)	<b>09.67521</b> ●	160752	43			
Vespa 150 P-X (78/81 - VLX1 c/frecce - s/batteria)	<b>09.6754</b> □ <b>09.67541</b> ●	149185 149185	43 43	<b>09.6745</b> □ <b>09.67451</b> ●	163132 163132	45 45
Vespa 150 P-X (78/80 - VLX1 fino a 157958 c/frecce - c/batteria 6V)				<b>09.4516</b> □	164516	45
Vespa 150 P-X (80/81 - VLX1 da 157959 c/frecce - c/batteria 12V)	<b>09.8790</b> □	187900	44	<b>09.4516</b> □	164516	45
Vespa 150 P-X (78/81 - VLX1 c/frecce - c/batteria 12V - Austria)				<b>09.94301</b> ●	162367/219430	45
Vespa 150 PX-E (81/83 - VLX1 s/frecce - Impianto 6 Volt)	<b>09.6740</b> □	160740	43			
Vespa 150 PX-E (81/83 - VLX1 s/frecce - Impianto 12 Volt)	<b>09.6754</b> □	149185	43			
Vespa 150 PX-E (81 - VLX1 fino a 410580 c/frecce - s/batteria)	<b>09.6754</b> □ <b>09.67541</b> ●	149185 149185	43 43	<b>09.6745</b> □ <b>09.67451</b> ●	163132 163132	45 45
Vespa 150 PX-E (82/83 - VLX1 da 410581 c/frecce - s/batteria)	<b>09.5668</b> □	215668	43	<b>09.56697</b> ●	215669	45
Vespa 150 PX-E (81/83 - VLX1 c/frecce - c/batteria)	<b>09.8790</b> □	187900	44	<b>09.4516</b> □	164516	45
Vespa 150 PX-E Arcobaleno (83/97 - VLX1 c/frecce - s/batteria)	<b>09.92111</b> ●	217898/232240	44	<b>09.78491</b> ●	215968/580395	45
Vespa 150 PX-E Arcobaleno (84/97 - VLX1 c/frecce - c/avv.to)	<b>09.9430</b> □	218822/231850	44	<b>09.7843</b> □	217343/2318515	45
Vespa 150 PX-E Arcobaleno (84/97 VLX1 c/batteria - estero)	<b>09.9430</b> □	218822/231850	44	<b>09.7843</b> □	217343/2318515	45
Vespa 150 PX-E Arcobaleno (83/97 - VLX1 Austria)				<b>09.94301</b> ●	219430	45
Vespa 150 PX-E (98/01 - VLX1)				<b>09.78491</b> ●	231849/580395	45
Vespa 150 PX (11)				<b>09.78491</b> ●	231849/580395	45
Vespa 200 P-X (77 - VSX1 da 100 a 1700 s/frecce)	<b>09.6740</b> □		43			
Vespa 200 P-E (77/82 - VSX1 s/frecce - Impianto 6 Volt)	<b>09.6740</b> □	160740	43			
Vespa 200 P-E (77/81 - VSX1 fino a 137653 c/frecce - s/batteria)	<b>09.6754</b> □ <b>09.67541</b> ●	149185 149185	43 43	<b>09.6745</b> □ <b>09.67451</b> ●	163132 163132	45 45
Vespa 200 P-E (82 - VSX1 da 137654 c/frecce - s/batteria)	<b>09.5668</b> □	215668	43	<b>09.56697</b> ●	215669	45
Vespa 200 P-E (77/79 - VSX1 fino a 33624 c/frecce - c/batteria 6V)				<b>09.4516</b> □	164516	45
Vespa 200 P-E (79/82 - VSX1 da 33625 c/frecce - c/batteria 12V)	<b>09.8790</b> □	187900	44	<b>09.4516</b> □	164516	45
Vespa 200 P-E (77/82 - VSX1 Austria)				<b>09.94301</b> ●	162354/219430	45
Vespa 200 PX-E (82/83 - VSX1 s/frecce - Impianto 6 Volt)	<b>09.6740</b> □	160740	43			
Vespa 200 PX-E (82/83 - VSX1 s/frecce - Impianto 12 Volt)	<b>09.6754</b> □ <b>09.67541</b> ●	149185 149185	43 43			
Vespa 200 PX-E (82/83 - VSX1 c/frecce - s/batteria)	<b>09.5668</b> □	215668	43	<b>09.56697</b> ●	215669	45
Vespa 200 PX-E (82/83 - VSX1 c/frecce - c/batteria)	<b>09.8790</b> □	187900	44	<b>09.4516</b> □	164516	45
Vespa 200 PX-E (82/83 - VSX1 Austria)				<b>09.94301</b> ●	187949/219430	45
Vespa 200 PX-E Arcobaleno (83/97 - VSX1 c/frecce - s/batteria)	<b>09.92111</b> ●	217898/232240	44	<b>09.78491</b> ●	215968/580395	45
Vespa 200 PX-E Arcobaleno (84/97 - VSX1 c/frecce - c/avv.to)	<b>09.9430</b> □	218822/231850	44	<b>09.7843</b> □	217343/2318515	45
Vespa 200 PX-E Arcobaleno (83/97 - VSX1 c/batteria - estero)	<b>09.9430</b> □	218822/231850	44	<b>09.7843</b> □	217343/2318515	45
Vespa 200 PX-E Arcobaleno (83/97 - VSX1 c/batteria - Austria)				<b>09.94301</b> ●	219430	45
Vespa 200 PX-E Arcobaleno (84/97 - VSX1 c/avv.to - Austria)				<b>09.94301</b> ●	219430	45
Vespa 200 PX-E (98/01 - VSX1)				<b>09.78491</b> ●	231849/580395	45

## VESPA PK

Vespa 50 PK S (83/85 - V5X2 3000001/> c/frecce - c/avv.to)				<b>09.7843</b> □	217343/2318515	45
Vespa 50 PK S (82/84 - V5X2 fino a 180978 c/frecce - s/avv.to - Austria)	<b>09.6779</b> □	216779	43	<b>09.78491</b> ●	215968/580395	45
Vespa 50 PK S (84/86 - V5X2 da 180979 c/frecce - s/avv.to - Austria)				<b>09.78491</b> ●	215968/580395	45
Vespa 50 PK S (82/85 - V5X2 c/frecce - s/avv.to - UK)	<b>09.6779</b> □	216779	43	<b>09.78491</b> ●	215968/580395	45
Vespa 50 PK S (82/85 - V5X2 c/frecce - s/avv.to - Germania)				<b>09.78491</b> ●	215968/580395	45
Vespa 50 PK SS (82/85 - V5S1 c/frecce - s/avv.to)	<b>09.6779</b> □	216779	43	<b>09.78491</b> ●	215968/580395	45

□ Di primo equipaggiamento

● Adattabile



Marca, c.c., modello, anno	COMMUTATORI LUCI		Fig. pag.	COMMUTATORE FRECCHE		Fig. pag.		
	Cod. SGR	Rif. originale		Cod. SGR	Rif. originale			
Vespa 50 PK SS (83/85 - V5S1 c/frecce - c/avv.to)	09.6779	□	216779	43	09.7843	□	217343/2318515	45
Vespa 50 PK S Automatica (84/89 - VA51 c/frecce - s/avv.to)					09.78491	●	232214/580395	45
Vespa 50 PK S Automatica (84/89 - VA51 c/frecce - c/avv.to)					09.7843	□	232202/2318515	45
Vespa 50 PK S Automatica (84/89 - VA51 c/frecce - s/avv.to - Austria)					09.78491	●	232214/580395	45
Vespa 50 PK S Automatica (84/89 - VA51 c/frecce - c/avv.to - Austria)					09.7843	□	232202/2318515	45
Vespa 50 PK S Automatica (84/89 - VA51 c/frecce - UK/Belgio)					09.7843	□	232202/2318515	45
Vespa 50 PK XL (85/88 - V5X3)					09.78491	●	231849/580395	45
Vespa 50 PK XLS (86/90 - V5S2)					09.78491	●	231849/580395	45
Vespa 50 PK XL/XLS Plurimatic (85/90 - VA52 s/avv.to)					09.78491	●	231849/580395	45
Vespa 50 PK XL/XLS Plurimatic (86/90 - VA52 c/avv.to)					09.7843	□	217343/2318515	45
Vespa 50 PK XL Rush (88/90 - V5X4 s/avv.to)					09.78491	●	231849/580395	45
Vespa 50 PK XL Rush (88/89 - V5X4 fino a 3001928 c/avv.to)					09.78491	●	231849/580395	45
Vespa 50 PK XL Rush (89/90 - V5X4 da 3001929 c/avv.to)					09.7843	□	217343/2318515	45
Vespa 50 PK N (89/90 - V5X5 c/avv.to)					09.78491	●	231849/580395	45
Vespa 50 PK N Speedmatic (89/90 - V5P1)					09.7843	□	217343/2318515	45
Vespa 125 PK S (82/85 - VMX5 c/frecce - s/avv.to)	09.6779	□	216779	43	09.78491	●	231849/580395	45
Vespa 125 PK S (83/85 - VMX5 c/frecce - c/avv.to)	09.6779	□	216779	43	09.7843	□	217343/2318515	45
Vespa 125 PK S (82/85 - VMX5 c/frecce - Austria)					09.94301	●	219430	45
Vespa 125 PK S Automatica (84/89 - VAM1 s/avv.to)	09.6779	□	232207/216779	43	09.78491	●	231849/580395	45
Vespa 125 PK S Automatica (84/89 - VAM1 c/avv.to)					09.7843	□	217343/2318515	45
Vespa 125 PK S Automatica (84/89 - VAM1 Austria)					09.94301	●	219430	45
Vespa 125 PK XL/XLS (86/88 - VMX6 s/avv.to)	09.7474	□	231074/2310745	44	09.78491	●	231849/580395	45
Vespa 125 PK XL/XLS (86/88 - VMX6 c/avv.to)	09.9430	□	218822/231850	44	09.78491	●	231849/580395	45
Vespa 125 PK P ETS (84/85 - VMS1 s/avv.to)	09.7474	□	231074/2310745	44	09.78491	●	231849/580395	45
Vespa 125 PK P ETS (84/85 - VMS1 c/avv.to)	09.9430	□	218822/231850	44	09.78491	●	231849/580395	45

## APE

Ape 50 (69/71 - TL1 da 1001 a 15096)	09.4013	□	092654	42				
Ape 50 (69/80 - TL1/TL2 estero)	09.4311	□	057663	42				
Ape 50 (71/73 - TL2 da 15097 a 24462)	09.4013	□	092654	42				
Ape 50 (73/80 - TL2 da 24462 a 80000)	09.4013	□	092654	42	09.61351	●	061350	44
Ape P 50 (84/85 - TL3 da 55952 acc. elettronica - s/avv.to elettrico)	09.7284	□	217284	44				
Ape P 50 (84/85 - TL3 da 500001 acc. elettronica - c/avv.to elettrico)	09.7267	□	230267	44				
Ape TM P 50 (85/89 - TL4 s/avv.to elettrico)	09.7284	□	217284	44				
Ape TM P 50 (85/89 - TL4 c/avv.to elettrico)	09.7267	□	230267	44	09.1471	□	230471/2304715	44
Ape FL 50 (89/90 - TL6 fino a telaio 20000)	09.7267	□	230267	44	09.1471	□	230471/2304715	44
125 Ape 350 (67/71 - AE02)	09.4311	□	057663	42				
125 Ape 250 (70/74 - TM1)	09.4311	□	057663	42				
150 Ape C (62/67 - AC4)	09.4311	□	057663	42				
150 Ape Pentarò (61/64 - APB1)					09.61351	●	061350	44
150 Ape 400 (67/73 - AE2)	09.4311	□	057663	42				
175 Ape D 450 (64/66 - AD1)	09.4311	□	057663	42				
175 Ape D 500 (66/74 - AD2)	09.4311	□	057663	42				
175 Ape D 500 Calessino (72 - AD2)	09.4311	□	057663	42				
175 Ape Pentarò (64/68 - APC1/APC2)					09.61351	●	061350	44
175 Ape 400R (70/78 - AE3 fino a 38000)	09.4311	□	057663	42				
175 Ape MP P401 (78/81 - AE3 da 38001)	09.6753	□	185267/186454	43				
190 Ape MP 500 (68/78 - MPR1)	09.4311	□	057663	42				
190 Ape MP P501 (78/93 - MPR2)	09.6753	□	185267/186454	43				
190 Ape MP 550 (67/72 - MPA1)	09.4311	□	057663	42				
190 Ape MP 550 Calessino (69 - MPAC1)	09.4311	□	057663	42				
190 Ape MP 600 (70/78 - MPM1 fino a 108193)	09.4311	□	057663	42				
190 Ape MP P601 (78/87 - MPM1 da 108194)	09.6753	□	185267/186454	43				
220 Ape MP P601 (78/85 - MPM2)	09.6753	□	185267/186454	43				

## Commutatori luci e frecce Piaggio Vespa-Ape

**09.3324** commutatore luci/claxon cromato



Di primo equipaggiamento su:

**Piaggio Vespa 125 ET3** • Vespa 200 Rally (72/79 - s/batteria)

*Rif. orig.: 143324*

**09.3781** commutatore luci/claxon cromato



Di primo equipaggiamento su (veicoli c/batteria):

**Piaggio Vespa 125 GTR** (69/78) • Vespa 125 TS (75/78)  
Vespa 125 Super (65/69 - estero) • Vespa 150 Sprint (65/74 - estero)  
Vespa 150 Sprint Veloce (69/79) • Vespa 150 Super (74/79)  
Vespa 150 (59/62) • Vespa 150 GL (62/65)

*Rif. orig.: 087558 • 029865*

**09.3954** commutatore luci/claxon cromato

**09.39541** commutatore luci/claxon cromato adattabile



Di primo equipaggiamento su:

**Piaggio Vespa 125 Super** (65/69) • Vespa 150 (62/67)  
Vespa 150 Super (66/79) • Vespa 125 Primavera (67/83)  
Vespa 125 (61/67 - s/batteria) • Vespa 90/SuperSprint/Racer (63/>)  
Vespa 125 TS • Vespa 125 GT (66/73) • Vespa 180 Rally (s/batteria)  
Vespa 125 GTR (69/78) • Vespa 150 Sprint/Veloce (65/79)  
Vespa GS 160 (s/batteria) • Vespa 180 SS (s/batteria)

*Rif. orig.: 092041*

**09.4311** commutatore luci/claxon cromato

Di primo equipaggiamento su:

**Piaggio Ape 150** (AC4 - 62/66) • Ape 250 (125 cc. - TM1 - 70/74)  
Ape 450 (175 cc. - AD1 - 64/66) • Ape 350 (67/71 - AEO2)  
Ape MP 400/R (150/175 cc. - 65/78) • Ape MP 550 (67/72)  
Ape MP 500 (69/78) • Ape MP 600 (70/78) • Ape 50 (69/80 - estero)

*Rif. orig.: 057663*

**09.6457** commutatore "Siem" luci/claxon cromato



Di primo equipaggiamento su:

**Piaggio Vespa 150 GS** (55/61)  
Vespa 160 GS (62/64 - c/batteria)

*Rif. orig.: 026457*

**09.3680** commutatore luci/claxon cromato



Di primo equipaggiamento su:

**Piaggio Vespa 200 Rally** (72/79 - c/batteria)

*Rif. orig.: 143680*

**09.37811** commutatore luci/claxon cromato



Adattabile su:

**Piaggio Vespa 50/N** (63/65 - estero) • Vespa 50 S (63/65)  
Vespa 125 (57/59 - s/batteria) • Vespa 125 (59/61 - c/batteria)  
Vespa 150 (57/59 - c/batteria) • Vespa 150 GL (57/58 - c/batteria - estero)

*Rif. orig.: 089471/95463/26645*

**09.4013** commutatore luci/claxon cromato



Di primo equipaggiamento su:

**Piaggio Vespa 50/L/R** (63/83) • Ape 50 TL1/TL2 (69/80)  
Vespa 50 S (estero) • Vespa 50/90 SuperSprint/Sprinter/Racer (estero)  
Vespa 125/ET3/Primavera (estero) • Vespa 125 GT (estero)  
Vespa 150 Super (74/79 - c/fanale Siem)  
Vespa 150 Sprint Veloce (74/79 - c/fanale Siem)  
Vespa 125 GTR (69/78 - c/fanale Siem) • Vespa Rally 180 (estero - c/batteria)

*Rif. orig.: 092654*

**09.7169** commutatore luci/claxon cromato



Di primo equipaggiamento su:

**Piaggio Vespa 50/N** (65/71 - da telaio 92877 - c/luce stop - estero)  
Vespa 50 S (65/82 - da telaio 13625) • Vespa 50 SS Super Sprint (65/71)  
Vespa 50 Sprinter (71/73)

*Rif. orig.: 073169*

**09.5668** commutatore luci/claxonDi primo equipaggiamento su:**Piaggio** Vespa PX-E (82/83 - VNX2 da telaio 100050 - c/frecce - s/batteria)

Vespa 150 PX-E (82/83 - VLX1 da telaio 410581 - c/frecce - s/batteria)

Vespa 200 P-E (82 - VSX1 da telaio 137654 - c/frecce - s/batteria)

Vespa 200 PX-E (82/83 - c/frecce - s/batteria)

Rif. orig.: 2156685

**09.6740** commutatore luci/claxonDi primo equipaggiamento su:**Piaggio** Vespa 125 PX-E (81/83 - s/frecce - s/batteria)

Vespa 150 PX-E (81/83 - s/frecce - s/batteria)

Vespa 200 P-E (77/82 - s/frecce - s/batteria) • 200 PX-E (s/frecce - s/batteria)

Rif. orig.: 160740

**09.67521** commutatore luci/claxonAdattabile su:**Piaggio** Vespa 125 P-X (77/82 - s/frecce)

Vespa P 150 S (s/frecce)

Vespa 150 P-X (78/81 - s/frecce)

Rif. orig.: 160752

**09.6753** commutatore luci/claxonDi primo equipaggiamento su:**Piaggio** 175 Ape MP P401 (78/81)

190 Ape MP P501 (78/93)

190 Ape MP P601 (78/87)

220 Ape MP P601 (78/85)

Rif. orig.: 185267 • 186454

**09.6754** commutatore luci/claxon**09.67541** commutatore luci/claxon adattabileDi primo equipaggiamento su:**Piaggio** Vespa P125/150 X (77/82 - c/frecce - s/batteria)

Vespa PX-E 125/150 E (81 - c/frecce - s/batteria)

Vespa PX-E 125/150/200 (81/83 - s/frecce - s/batteria - imp. 12V - estero)

Vespa P 150 S (78/84 - c/frecce - s/batteria)

Vespa P 200 E (77/81 - c/frecce - s/batteria)

Rif. orig.: 149185

**09.6779** commutatore luci/claxon c/simboliDi primo equipaggiamento su:**Piaggio** Vespa PK 50 SS (83/86 - c/frecce)

Vespa PK 125 S (83/86 - c/frecce)

Vespa PK 125 S Automatica (84/89 - c/frecce - s/avv.to elettrico)

Rif. orig.: 216779

**09.7250** commutatore luci/claxon  
**09.72501** commutatore luci/claxon adattabile



Di primo equipaggiamento su:  
**Piaggio Vespa 50 R (69/76 - Francia) • Vespa 50 Special (69/83)**  
**Vespa 50 Special Revival (91)**  
*Rif. orig.: 123152*

**09.7267** commutatore luci/claxon c/simboli



Di primo equipaggiamento su:  
**Piaggio Ape P 50 TL3 (84/85 - c/avv.to elettrico)**  
**Ape TMP 50 TL4 (85/89 - c/avv.to elettrico)**  
**Ape 50 FL TL6 (89/90 - fino a telaio 20000)**  
*Rif. orig.: 230267*

**09.7284** commutatore luci/claxon  
 c/simboli



Di primo equipaggiamento su:  
**Piaggio Ape P 50 TL3 (84/85 - acc. elettronica - s/avv.to elettrico)**  
**Ape TMP 50 TL4 (85/89 - s/avv.to elettrico)**  
*Rif. orig.: 217284*

**09.7474** commutatore luci/claxon  
 c/simboli



Di primo equipaggiamento su:  
**Piaggio Vespa PK 125 XL (86/89 - s/avv.to elettrico)**  
**Vespa P 125 ETS (84/85 - s/avv.to elettrico)**  
*Rif. orig.: 2310745*

**09.8790** commutatore luci/claxon



Di primo equipaggiamento su:  
**Piaggio Vespa 125 P-X (77/82 - c/frecce - c/batteria)**  
**Vespa 125 PX-E (81/83 - c/frecce - c/batteria)**  
**Vespa 150 P-X (78/81 - c/frecce - c/batteria) • 150 PX-E (81/83 - c/frecce - c/batteria)**  
**Vespa 200 P-E (77/82 - c/frecce - c/batteria) • 200 PX-E (82/83 - c/frecce - c/batteria)**  
*Rif. orig.: 187900*

**09.92111** commutatore luci/claxon  
 c/simboli

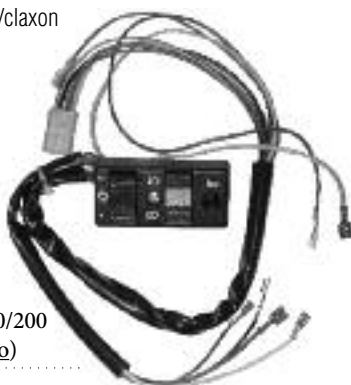

Adattabile su:  
**Piaggio Vespa PX-E 125/150/200**  
**Arcobaleno (s/avv.to elettrico)**  
*Rif. orig.: 217898 • 232240*

**09.9430** commutatore luci/claxon c/simboli



Di primo equipaggiamento su:  
**Piaggio Vespa PK 125 XL**  
**(86/89 - c/avv.to elettrico)**  
**P 125 ETS (84/85 - c/avv.to elettrico)**  
**125/150/200 PX-E Arcobaleno (c/avv.to elettrico)**  
*Rif. orig.: 231850*

**09.61351** commutatore frecce cromato - 3 posizioni



Adattabile su:  
**Piaggio Ape 50 TL2 (71/80)**  
**Vespa 50 S V5SA1 (63/82) • 50 Sprinter V5SS2 (71/73 - estero)**  
**90 V9A1 (63/84 - estero) • 90 SuperSprint V9SS1 (65/71 - estero)**  
**90 Racer V9SS2 (71/73 - estero) • 125/Primavera/ET3 (65/83 - estero)**  
**125 GTR VNL2 (69/78) • 125 Super VNC1 (65/69 - estero)**  
**150 Super VBC1 (65/79) • 150 Sprint VLB1 (65/74 - estero)**  
**150 Sprint Veloce VLB1 (69/79) • 180 Rally VSD1 (68/73 - estero)**  
**200 Rally VSE1 (72/79)**  
*Rif. orig.: 061350*

**09.1471** commutatore frecce



Di primo equipaggiamento su:  
**Piaggio Ape TMP 50 (85/89 - c/avv.to elettrico)**  
**Ape 50 FL TL6 (89/90 - fino a telaio 20000)**  
*Rif. orig.: 2304715*

**09.4516** commutatore frecceDi primo equipaggiamento su:

**Piaggio** Vespa 125 P-X (77/82 - c/frecce - c/batteria)  
 Vespa 125 PX-E (81/83 - c/frecce - c/batteria)  
 Vespa 150 P-X (78/81 - c/frecce - c/batteria) • Vespa 150 PX-E (81/83 - c/frecce - c/batteria)  
 Vespa 200 P-E (77/82 - c/frecce - c/batteria) • Vespa 200 PX-E (82/83 - c/frecce - c/batteria)

Rif. orig.: 164516

**09.56697** commutatore frecceAdattabile su:

**Piaggio** Vespa PX 125 E (82/83 - VNX2T - da telaio 100050 a 200000)  
 Vespa PX 150 E (82/83 - VLX1T - da telaio 410581 a 600000)  
 Vespa P 200 E (82 - VSX1 - da telaio 137654) • PX 200 E (82/83)

Rif. orig.: 215669

**09.6745** commutatore frecce**09.67451** commutatore frecce adattabileDi primo equipaggiamento su:

**Piaggio** Vespa P 125/150 X (77/81 - s/batteria)  
 Vespa PX 125/150 E (81 - s/batteria)  
 P 150 S (s/batteria) • P 200 E (77/81 - s/batteria)

Rif. orig.: 163132

**09.7843** commutatore frecce c/simboliDi primo equipaggiamento su:

**Piaggio** Vespa PK 50 S/SS (c/avv.to elettrico) • Vespa PK 50 S Automatica (84/89 - c/avv.to elettrico)  
 Vespa PK 50 XL Plurimatic (85/90 - c/avv.to elettrico) • Vespa PK 50 XL Rush (86/90 - c/avv.to elettrico)  
 Vespa PK 50 N Speedmatic (90 - c/avv.to elettrico) • Vespa PK 125 S (83/86 - c/avv.to elettrico)  
 Vespa PK 125 S Automatica (84/89 - c/avv.to elettrico)  
 Vespa 125/150/200 PX-E Arcobaleno (84/97 - c/avv.to elettrico)

Rif. orig.: 2318515

**09.78491** commutatore frecce c/simboliAdattabile su:

**Piaggio** Vespa PK 50 S/SS (s/avv.to)  
 Vespa PK 50 Automatica (s/avv.to)  
 Vespa PK 50 XL/Rush • PK 50 N  
 Vespa PK 50 XL Plurimatic (s/avv.to)  
 Vespa PK 125 S/S Automatica (s/avv.to)  
 P 125 ETS • PK 125 XL • PX 125 T5  
 PX-E 125/150/200 Arcobaleno (s/avv.to)  
 PX-E 125/150/200 (98/01) • PX 125 Euro 2  
 PX 125 30 Anni (07/08) • PX 125/150 (11)

Rif. orig.: 231849 • 215968 • 232214 • 580935

**09.94301** commutatore frecce c/lampeggio c/simboliAdattabile su:

**Piaggio** Vespa 125/150/200 P-X/P-E (77/82 - Austria)  
 Vespa 125/150/200 PX-E (81/83 - Austria)  
 Vespa 125/150/200 PX-E Arcobaleno (83/97 - Austria - c/batteria)

Rif. orig.: 219211

## Commutatori e pulsanti vari per ciclomotori e moto

**02.7203** commutatore luci a fascetta - in nylon nero  
3 posizioni - c/pulsante stop e pulsante claxonAdattabile su:  
ciclomotori vari**02.7694** commutatore luci a fascetta cromatoAdattabile su:  
ciclomotori vari

**02.77331** commutatore a fascetta per frecce - in nylon nero



Adattabile su:  
**moto e ciclomotori vari**

**09.3367** pulsante cavalletto elettrico



Di primo equipaggiamento su:  
**Piaggio Hexagon 125/150 2T (94/97)**  
*Rif. orig.: 293280*

**02.7698** pulsante claxon rosso s/cavo



Adattabile su:  
**Piaggio Ciao (67/70) e applicazioni varie**  
*Rif. orig.: 104400*

**02.7195** pulsante massa/avviamento



Di primo equipaggiamento su:  
**Piaggio Vespa 200 Rally · Ape MP 500/550/600 · MP 501**  
**Innocenti Lambro 550 V**  
*Rif. Piaggio: 073185*  
*Rif. Innocenti: 42081130*

**02.9740** pulsante massa/avviamento impermeabile a/fascetta "**Leonelli**"  
c/cavi - cablaggio 600 mm. c/2 capocorda  
(1 occhiello/1 faston femmina)



Adattabile su:  
**Beta · Bultaco · HM · Ossa · Montesa · Motocross/trial varie**

*Sostituisce: 96.9740004*

**09.5622** commutatore luci c/simboli colorati



Di primo equipaggiamento su:  
**Piaggio Grillo 50 (c/frecce)**  
*Rif. orig.: 255622 · 291513*

**09.6101** pulsante claxon grigio - c/cavo nero 700 mm.



Di primo equipaggiamento su:  
**Piaggio Bravo 1/R2 · Boxer · Si**  
**Ciao PX/SC/R2/Arcob./SC R2/SC Arcob.**  
*Rif. orig.: 186101 (122358/125643/128598)*

**02.7955** interruttore luci al faro c/cavo



Adattabile su:  
**Piaggio Ciao Special/PX/R/R2/SC/Arcobaleno**  
**Si FL2 (s/frecce) · Bravo EVL · Boxer**  
*Rif. orig.: 126335 · 163208 · 122237 · 122235 · 163124 · 186102*

**02.7697** pulsante avviamento speciale c/contatti argentati, cappuccio e bottone nero • 12V/15A • 24V/7A  
Ø 21,5 mm - 2 faston laterali

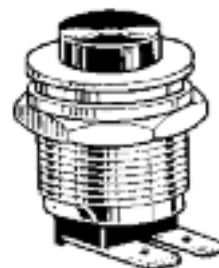

Adattabile su:  
**muletti, trattori e applicazioni varie**

**02.9710** dispositivo di sicurezza magnetico arresto motore "**Leonelli**"  
a/fascetta - c/cavi  
cablaggio 600 mm. c/2 capocorda (1 occhiello/1 faston femmina)



Adattabile su:  
**universale moto/quad**

**OBLIGATORIO NEL CAMPIONATO TRIAL 2011**

## Tabella orientativa applicazioni claxon e trombe

Applicazione	Cod. SGR	Rif. originale / Note	Caratteristiche tecniche	Fig. pag.
<b>APRILIA</b>				
50 AF1 • ET • Tuareg (87) • 50 ETX (85/86)	09.7504 ●	8212117/064	12V-28W CA	54
50 AF1/Sintesi/Replica/Europa/Futura	09.7522 ●	AP8212228	12V CC - nero	57
50 Amico • Area 51 • Gulliver • Rally	09.7391 ●	AP8112413	12V CC - nero	56
50 Classic (92/99) • 50 Red Rose (89/92)	09.7522 ●	AP8224179	12V CC - nero	57
50 Habana/Custom	09.7391 ●	AP8224221	12V CC - nero	56
50 RS (92/10) • 50 RX (89/10)	09.7522 ●	AP8224179	12V CC - nero	57
50 Scarabeo 2t (93/97) • 50 SR tutti	09.7391 ●	AP8212587/611	12V CC - nero	56
50/100 Scarabeo 2t/4t (98/11)	09.7520 □	AP8224038	12V CC	57
50 Tuareg Rally/Wind (90)	09.7522 ●	AP8212228	12V CC - nero	57
125 Habana/Mojito/Custom	09.7522 ●	AP8124530	12V CC - nero	57
125 AF1 • 125 ETX (85/87) • 125 Tuareg Rally	09.7500 □	AP8124747	12V CC - nero	57
125 AF1 Sintesi/Replica/Europa/Futura	09.7522 ●	AP8112413	12V CC - nero	57
125 ETX (98) • 125 Pegaso	09.7522 ●	AP8124524	12V CC - nero	57
125 Classic • 125 Red Rose	09.7500 □	AP8124747	12V CC - nero	57
125 Tuareg Wind (88/89)	09.7522 ●	AP8112413	12V CC - nero	57
125/250 Tuareg (Imp. 6V)	09.7387 ●		6V CC - zincato	56
125/250 RS (99/05)	09.7522 ●	AP8124530	12V CC - nero	57
125/150/250/300 Leonardo/ST • 125/150 SR	09.7522 ●	AP8124598	12V CC - nero	57
125/200/250/300 Atlantic/Sportcity/Cube	09.7522 ●	AP8127337	12V CC - nero	57
125/150/200 Scarabeo	09.7522 ●	AP8124598	12V CC - nero	57
250/300/400/500 Scarabeo Light (06/10)	09.7516 □	58034R	12V CC	57
400/500 Atlantic Sprint (05/09)	09.7522 ●	AP8127337	12V CC - nero	57
500 Atlantic • 500 Scarabeo	09.7522 ●	AP8124598	12V CC - nero	57
350/600 ETX (85/86) • 600 Pegaso	09.7500 ●	AP8112201	12V CC - nero	57
350/600 ETX (87/>) • 350/600 Tuareg Wind	09.7522 ●	AP8112413	12V CC - nero	57
650 Pegaso (</96)	09.7500 □	AP8124747	12V CC - nero	57
650 Pegaso 3/IE • 660 Pegaso	09.7522 ●	AP8127337	12V CC - nero	57
1000 RSV/R/SP (98/00)	09.7500 □	AP8124747	12V CC - nero	57
1000 RST Futura	09.7535 ●	AP8127336	12V CC - nero	58
1000 ETV Capo Nord	09.7522 ●	AP8124598	12V CC - nero	57
<b>BENELLI</b>				
50 491 • 50 Naked • 50/100 K2	09.7391 ●		12V CC - nero	56
124 2C/4 tempi	09.7386 ●	61743700	12V CC - zincato	56
125 BX • 125 Jarno • 125 Devil	09.7386 ●	27743715	12V CC - zincato	56
125/150/250 Velvet	09.7522 ●		12V CC - nero	57
125 Leoncino/Turismo/Sport • 125/250 2C	09.7387 ●	39743700	6V CC - zincato	56
125/250 Motobi 4T-Monocil.	09.7387 ●		6V CC - zincato	56
350 RS • 354 • 500 LS • 504 • 654	09.7386 ●	61743700	12V CC - zincato	56
650 Tornado • 750 SEI	09.7386 ●		12V CC - zincato	56
900 SEI	09.7383 □	GU14743700/01	12V CC - coppia	55
<b>CAGIVA</b>				
50 City • 50 Cocis	09.7391 ●	800070590	12V CC - nero	56
125 Aletta Oro S1/GP S2 • 125 Elefant 2	09.7386 □	5164011AB	12V CC - zincato	56
125 Blues	09.7383 □	800058975/976	12V CC - coppia	55
125 Cruiser • 125 Elefantre • 125 Roadster	09.7345 □	80A050555	12V CC - nero	55
125 Freccia C9/C10R/C12R • 125 N90	09.7345 □	80A050555	12V CC - nero	55
125 K3 • 125 K7 • 125 W8/FA	09.7391 ●	800052577	12V CC - nero	56
125 Mito • 125 Planet • 125 Raptor	09.7386 □	5164011AB	12V CC - zincato	56

Applicazione	Cod. SGR	Rif. originale / Note	Caratteristiche tecniche	Fig. pag.
125 SST/Aletta Elektra • 125 Tamanaco	<b>09.7345</b> ●	800017964	12V CC - nero	55
125 SST Low Rider	<b>09.7382</b> □		12V CC - <u>coppia trombe</u>	55
125 SXT (82/>) • 125 Supercity	<b>09.7386</b> □	5164011AB	12V CC - zincato	56
125 WSXT Aletta Rossa • 200 Elefant	<b>09.7386</b> □	5164011AB	12V CC - zincato	56
250/350 Ala Blu/Ala Verde/SST/SX	<b>09.7386</b> □	5164011AB	12V CC - zincato	56
350 Ala Rossa • 350 W12 • 500 W16	<b>09.7386</b> □	5164011AB	12V CC - zincato	56
350/500 T4-R	<b>09.7391</b> ●	800052577	12V CC - nero	56
350/500 T4-E	<b>09.7345</b> □	80A050555	12V CC - nero	55
350/650/750 Elefant/Alazzurra	<b>09.7345</b> □	800042914	12V CC - nero	55
500/600 Canyon/River	<b>09.7386</b> □	5164011AB	12V CC - zincato	56
900 Elefant • 900 Grand Canyon	<b>09.7386</b> □	5164011AB	12V CC - zincato	56

## DERBI

50 Hunter • 50 Paddock • 50 Predator	<b>09.7391</b> ●	00F01001311	12V CC - nero	56
50/100 Atlantis 2t/4t • 50 GP1 • 50 GPR (</03)	<b>09.7391</b> ●	00F01001311	12V CC - nero	56
50 GPR (04/09) • 50 Senda R/SM (04/10)	<b>09.7522</b> ●	00H01005311	12V CC - nero	57
125 GPR 2T • 125 Senda R/SM 4T	<b>09.7391</b> ●	00F01001311	12V CC - nero	56

## DUCATI

160 Monza Junior/Turismo/Sport	<b>09.7387</b> ●	012038053	6V CC - zincato	56
200 Turismo/Elite • 250/350 Road (6V)	<b>09.7387</b> ●	012038053	6V CC - zincato	56
250 De Luxe • Road • 24H • Monza	<b>09.7387</b> ●	012038053	6V CC - zincato	56
250/350/450 Scrambler/Mark3/Desmo (6V)	<b>09.7387</b> ●	012038053	6V CC - zincato	56
250/350/450 Scrambler (12V)	<b>09.7386</b> ●		12V CC - zincato	56
250/350 Strada/Road/Forza/Vento (12V)	<b>09.7386</b> ●		12V CC - zincato	56
350/400 F3 • 350/500 GTL/GTV/Desmo	<b>09.7345</b> ●	080138050	12V CC - nero	55
400 Monster • 400 SuperSport	<b>09.7386</b> □	5164011AB	12V CC - zincato	56
350/500/600/650 Pantah/XL/TL/SL	<b>09.7345</b> ●	080138050	12V CC - nero	55
350/650/750 Indiana	<b>09.7383</b> ●	036138050	12V CC - <u>coppia</u>	55
600 Monster • 600 SuperSport • 620 Sport	<b>09.7386</b> □	5164011AB	12V CC - zincato	56
748/Bip./SP/R/S/SPS (95/02)	<b>09.7386</b> □	5164011AB	12V CC - zincato	56
750 F1 Pantah/Desmo • 750 SS Desmo	<b>09.7345</b> ●	080138050	12V CC - nero	55
750 Monster • 750 SuperSport/IE	<b>09.7386</b> □	5164011AB	12V CC - zincato	56
750 Paso • 750 Sport (88/90)	<b>09.7345</b> ●	037038050	12V CC - nero	55
800 Sport/SuperSport	<b>09.7386</b> □	5164011AB	12V CC - zincato	56
851 SuperBike • 888 SP5/SuperBike	<b>09.7386</b> □	5164011AB	12V CC - zincato	56
860/900 GT/GTS • 900 SS Desmo	<b>09.7345</b> ●	080138050	12V CC - nero	55
900 Monster/IE (93/01)	<b>09.7386</b> □	5164011AB	12V CC - zincato	56
900 SD/SSD Darmah S2/Desmo//MHR	<b>09.7345</b> ●	080138050	12V CC - nero	55
900 SuperSport/IE • 900 Sport	<b>09.7386</b> □	5164011AB	12V CC - zincato	56
916 • 996 tutti SP/Bip./Senna (94/98)	<b>09.7386</b> □	5164011AB	12V CC - zincato	56
916 ST4 • 944 ST2 • 996 ST4S	<b>09.7386</b> □	5164011AB	12V CC - zincato	56
998 (02/04) • 1098/S (07)	<b>09.7386</b> □	5164011AB	12V CC - zincato	56
1000 MHR Replica/S2/Desmo	<b>09.7345</b> ●	080138050	12V CC - nero	55
1000 ST3/S/ABS • 1000 SuperSport	<b>09.7386</b> □	5164011AB	12V CC - zincato	56

## GILERA

50 Bullit • 50 Eaglet	<b>09.7522</b> ●	580238	12V CC - nero	57
50 Easy Moving • 50 ICE • 50 Typhoon/X/XR	<b>09.7516</b> □	58034R	12V CC	57
50 Runner/SP • 50 Stalker • 50 Storm	<b>09.7516</b> □	CM071803	12V CC	57
125 SP01/SP02/CX	<b>09.7345</b> ●	324564	12V CC - nero	55
125 TG1/TG2/TG3	<b>09.7386</b> ●	311758	12V CC - zincato	56
125 RX LC/Trial • 125 MX1 • 125 Sport	<b>09.7522</b> ●	316743	12V CC - nero	57

□ Di primo equipaggiamento

● Adattabile



Applicazione	Cod. SGR	Rif. originale / Note	Caratteristiche tecniche	Fig. pag
125 XR1/XR2 • 125 RX/RV • 125 KK/KZ	<b>09.7386</b> ●	328038/322821	12V CC - zincato	56
125/150 Arcore 5V	<b>09.7387</b> ●	G/401078	6V CC - zincato	56
125/180/200 Runner 2T/4T	<b>09.7516</b> □	CM071803	12V CC	57
125/250/300/500 Nexus/IE	<b>09.7516</b> □	58034R	12V CC	57
200/250 RX Arizona/Hawk/Rally	<b>09.7386</b> ●	328038/322821	12V CC - zincato	56
350/500 Saturno (88/90) • 250 RV NGR	<b>09.7345</b> ●	322962/323890	12V CC - nero	55
350/500 Dakota ES/ER (86/90)	<b>09.7386</b> ●	328038	12V CC - zincato	56
350/600 XRT • 350/600 Nord West/Cape	<b>09.7345</b> ●	324564	12V CC - nero	55
600 RC/C/R/Cobra (89/93)	<b>09.7345</b> ●	324564	12V CC - nero	55

## HONDA

50 Dio/ZX/SR/SC01 • 50/90 Shadow	<b>09.7391</b> ●		12V CC - nero	56
50 Lead • 50 Vision • 50 Wallaroo	<b>09.7391</b> ●		12V CC - nero	56
50 Sky • 50 SFX/SXV • 50 X8R • 50/100 SH	<b>09.7391</b> ●		12V CC - nero	56
50/100 Bali	<b>09.7522</b> ●	38110KAY008	12V CC - nero	57
100 SCV Lead	<b>09.7391</b> ●	38110KRP903	12V CC - nero	56
125 CB S/X/Endurance • CS 125	<b>09.7387</b> □	38110KY0970	6V CC - zincato	56
125 NS F/R • 125/200 XL R (84/87)	<b>09.7522</b> ●	38110KB9620	12V CC - nero	57
125 XL S/SD (79/84)	<b>09.7390</b> ●	38110437004	6V CC - zincato	56
125/150 CH Elite	<b>09.7522</b> ●	38110MA6621	12V CC - nero	57
125/150 @Chiocciola • Dylan • Pantheon 4T	<b>09.7522</b> ●	38110KGF900	12V CC - nero	57
125/150 Pantheon 2T (98/02)	<b>09.7535</b> ●	38120MAK003	12V CC - nero	58
125/150 PS i	<b>09.7522</b> ●	38110KTZD00	12V CC - nero	57
125/150 SH/SH i	<b>09.7522</b> ●	38110KPR900	12V CC - nero	57
125/150 SilverWing (07/11)	<b>09.7522</b> ●	38110KRJ790	12V CC - nero	57
250 CN • 250 Jazz (01/04) • 300 SH	<b>09.7522</b> ●	38110KTW900	12V CC - nero	57
250 Foresight (98/99) • 250 Forza (05/07)	<b>09.7522</b> ●	38110KAY008	12V CC - nero	57
250 Foresight (00/05) • 250 Forza (08/11)	<b>09.7535</b> ●	38120MAK003	12V CC - nero	58
250 XL S (78/81) • 250 XL R (82/83)	<b>09.7390</b> ●	38110428900	6V CC - zincato	56
400 CB T (78/81) • 400 CM E (80/82)	<b>09.7522</b> ●	38110GJ1731	12V CC - nero	57
400 CB N • 400/550 CBX F • 450 CB S	<b>09.7522</b> ●	38110MA6000	12V CC - nero	57
400/600 FJS SilverWing	<b>09.7522</b> ●	38110MCT691	12V CC - nero	57
500 CX A/C/Custom/D	<b>09.7522</b> ●	38110GJ1731	12V CC - nero	57
500 FT (83/84) • 500 VT C (83/86)	<b>09.7522</b> ●	38110MJ0681	12V CC - nero	57
500 XL S (79/81)/R (82)	<b>09.7390</b> ●	38110435771	6V CC - zincato	56
500/750 VF F • 750 VFR	<b>09.7522</b> ●	38110KAY008	12V CC - nero	57
600 CB F Hornet/S (01/06)	<b>09.7535</b> □	38120MBZK00	12V CC - nero	58
600 VT C Shadow (88/90)	<b>09.7522</b> ●	38110KB9620	12V CC - nero	57
650 CB/C/SC NightHawk	<b>09.7522</b> ●	38110MJ0004	12V CC - nero	57
650 NT V Deauville • 650 SLR	<b>09.7535</b> ●	38120MAK003	12V CC - nero	58
650 NX Dominator (97/99)	<b>09.7535</b> ●	38120MAK003	12V CC - nero	58
750 CB C/SC NightHawk • 1100 CB F	<b>09.7522</b> ●	38110MJ0004	12V CC - nero	57
900 CB F Hornet (02/06)	<b>09.7535</b> □	38120MBZK00	12V CC - nero	58

## KAWASAKI

250 S1 A/B/C Mach I • 400/500 KZ/KH	<b>09.7522</b> ●	27003-1006/042	12V CC - nero	57
500 GPZ S (87/03)	<b>09.7383</b> ●	27003-1263/67	12V CC - <u>coppia</u>	55
550 KZ Spectre/LTD Shaft • 550 GPZ	<b>09.7383</b> ●	27003-1057/58	12V CC - <u>coppia</u>	55
650/750 KZ/Custom/LTD/SR/CSR	<b>09.7522</b> ●	27003-076	12V CC - nero	57
750 KZ (83) • 750 GPZ/Turbo (82/85)	<b>09.7383</b> ●	27003-1057/58	12V CC - <u>coppia</u>	55
900 KZ (76/77) • 1000 KZ/LTD (77/80)	<b>09.7522</b> ●	27003-1006	12V CC - nero	57
1000 KZ Shaft (79/80)	<b>09.7522</b> ●	27003-076	12V CC - nero	57
1100 GPZ (83/84)	<b>09.7383</b> ●	27003-1057/58	12V CC - <u>coppia</u>	55

□ Di primo equipaggiamento

● Adattabile

Applicazione	Cod. SGR	Rif. originale / Note	Caratteristiche tecniche	Fig. pag.
<b>KYMCO</b>				
50 Agility R10/R12	09.7391 ●	38110-KEB7-90A	12V CC - nero	56
50 Agility RS/R16 • 50 Super 8	09.7391 ●	38110-KGC4-B50	12V CC - nero	56
50 CX/Super • DJ X/Y/W • Fever ZX • Filly	09.7391 ●	38110-GS7-000	12V CC - nero	56
50 Heroism • KB/K12 • Sniper/DD • Top Boy	09.7391 ●	38110-GS7-000	12V CC - nero	56
50 Dink 2t/Classic • 50 GranDink 2t	09.7391 ●	38110-KEB7-90A	12V CC - nero	56
50 Dink 2t Classic Euro 2	09.7522 ●	38110-KBE-9000-M1	12V CC - nero	57
50 Dink 4 tempi	09.7522 ●	38110-LBA8-E0B	12V CC - nero	57
50 Like 2T/4T	09.7391 ●	38110-KGC4-B50	12V CC - nero	56
50 People • 50 Super 9 • 50 Vitality 2T/4T	09.7391 ●	38110-KEB7-90A	12V CC - nero	56
50 People S 2T/4T	09.7522 ●	38110-KHB4-E0A	12V CC - nero	57
125/150/200 Agility R12/R16 • 125/200 Like	09.7522 ●	38110-KHB4-E0A	12V CC - nero	57
125/150/200 Dink/LX/Classic/Euro 2	09.7522 ●	38110-KBE-9000-M1	12V CC - nero	57
125/150 Heroism • 125/150 Vivio	09.7522 ●	38110-KBE-9000-M1	12V CC - nero	57
125/150 People • 125/150 Movie/XL/Euro3	09.7522 ●	38110-KHB4-E0A	12V CC - nero	57
125/200 Dink Euro 3	09.7522 ●	38110-LEA5-E00	12V CC - nero	57
125/200/250/300 People S	09.7522 ●	38110-KHB4-E0A	12V CC - nero	57
125/200/300 Downtown i	09.7522 ●	38110-KKC3-90A	12V CC - nero	57
125/200/300 People GT i	09.7522 ●	38110-KHB4-E0A	12V CC - nero	57
125/150/250 Bet e Win/Euro 2	09.7522 ●	38110-KHB4-E0A	12V CC - nero	57
125/150/250 Gran Dink/Euro 2	09.7522 ●	38110-KKC3-90A	12V CC - nero	57
250/300/500 Xciting/IE/R	09.7522 ●	38110-KHB4-E0A	12V CC - nero	57
<b>LAVERDA</b>				
50 LZ	09.73181 ●	76502026	6V-18W CA nero-c/staffa	54
50 OR Atlas	09.7504 ●	76502028	12V-28W CA	54
125 GS Lesmo	09.7345 ●	76502029	12V CC - nero	55
350/500	09.7345 ●	76502016	12V CC - nero	55
600 OR Atlas	09.7386 ●	76502031	12V CC - zincato	56
668 Diamante/Ghost/Strike/Legend/Formula	09.7383 ●	076005000002	12V CC - coppia	55
750 S Formula/S Sport/Carenato/Strike	09.7345 ●	076005000004	12V CC - nero	55
1000 (</75)	09.7383 ●	76502015/16	12V CC - coppia	55
<b>MALAGUTI</b>				
50 Centro Base/SL (93/98)	09.7391 ●	01802300	12V CC - nero	56
50 Centro SLCat. (99/00)	09.7530 □	01805400	12V CC - zincato	58
50 Ciak/TD/Euro 2/2.3/Master 2T/4T (99/10)	09.7530 □	01805400	12V CC - zincato	58
50 Crosser • 50 Yesterday	09.7530 □	01805400	12V CC - zincato	58
50 F10/Rst/Euro 1/2/2.3/AC (92/10)	09.7530 □	01805400	12V CC - zincato	58
50/100 F12 Air/LC/Rst/Euro 1/2/2.3 (94/06)	09.7530 □	01805400	12V CC - zincato	58
50 F12 R Phantom LC/AC (07/10)	09.7522 ●	01808100	12V CC - nero	57
50 F15 Air/LC/Rst/Euro 1/2/2.3 (96/06)	09.7530 □	01805400	12V CC - zincato	58
50 Fifty HF/Top/RV/UPFull/CX/Evolution	09.7504 ●	01801400	12V-28W CA	54
50 MRX/MGX/MEX/MFX/MDX/Gold/JX/Mix/Dune	09.7504 ●	01801400	12V-28W CA	54
50 New Dribbling • 50 Sport RST (AE)	09.7504 ●	01801400	12V-28W CA	54
100/125/150/200 Ciak/Master/Euro 2/Euro 3	09.7530 □	01805400	12V CC - zincato	58
125 Runner (YLC)	09.7387 □	01800700	6V CC - zincato	56
125 Runner Rally (YPVS)	09.7530 ●	01800900	12V CC - zincato	58
125/150 F18 Warrior	09.7530 □	01805400	12V CC - zincato	58
125/150/180/200/250 Madison • Phantom Max	09.7530 □	01805400	12V CC - zincato	58
125/250 Madison 3 (06) • 250 Password	09.7522 ●	01808100	12V CC - nero	57
400 Madison • 500 SpiderMax GT	09.7530 □	01805400	12V CC - zincato	58

Applicazione	Cod. SGR	Rif. originale / Note	Caratteristiche tecniche	Fig. pag.
<b>MBK</b>				
50 Booster/Road/Rocket/Track/NG/Spirit/R/L	09.7391 ●	5SB-H3371-00	12V CC - nero	56
50 CT 50 S/SS Sorriso • 50 Evolis • 50 Forte	09.7391 ●	4CU-H3371-00	12V CC - nero	56
50 MachG • 50 Target • 50 Stunt • 50 Fizz	09.7391 ●	4CU-H3371-00	12V CC - nero	56
50/100 Ovetto • 50/100 Nitro	09.7391 ●	5SB-H3371-00	12V CC - nero	56
125/150 Flame/Vertex • 125/150 Doodo/Thunder	09.7535 ●	2KG-83371-00	12V CC - nero	58
125/150/180 Skyliner	09.7522 ●	5DS-H3371-00	12V CC - nero	57
250 Skyliner • 300 Kilibre	09.7535 ●	2KG-83371-00	12V CC - nero	58

## MOTO GUZZI

125 Custom • 125 TT	09.7386 ●	66743720	12V CC - zincato	56
250 TS	09.7387 ●	39743700	6V CC - zincato	56
350/500 V35/II/Imola/II/V50/II/III/Monza	09.7386 ●	GU61743700	12V CC - zincato	56
350/500 V35C/V50C Custom (81/86)	09.7386 ●	GU61743700	12V CC - zincato	56
350/500 V35/V50 Polizia/C.C./P.A. (90/01)	09.7382 ●	GU28743701/61	12V CC - coppia trombe	55
350/650 Florida V35/V65 (85/94)	09.7382 ●	GU29743752/53	12V CC - coppia trombe	55
350/650 35 GT/65 GT (87/89)	09.7382 ●	GU29743752/53	12V CC - coppia trombe	55
350/650/750 NTX • V35 TT/V65 TT	09.7386 ●	GU27743715	12V CC - zincato	56
350/750 Nevada (91/93)	09.7382 ●	GU28743701/61	12V CC - coppia trombe	55
650 V65/C • V65 SP • V65 Lario	09.7386 ●	GU61743700	12V CC - zincato	56
700 V7 (67/> - Marelli T12 DE/F)	09.7345 ●	12743700	12V CC - nero	55
700 V7 (70/> - Bosch 0320023001)	09.7386 ●	25743701	12V CC - zincato	56
750 Targa • 750 Strada	09.7386 ●	GU61743700	12V CC - zincato	56
750 S (74/>)	09.7383 ●	GU14743700/01	12V CC - coppia	55
750 SP (90/92)	09.7382 ●	GU28743701/61	12V CC - coppia trombe	55
750 V7 Ambassador (70/>)	09.7345 ●	12743700	12V CC - nero	55
750 V7 Sport (71/73)	09.7383 ●	GU14743700/01	12V CC - coppia	55
750 V7 Special (70/>)	09.7386 ●	25743701	12V CC - zincato	56
750 V75 P.A. (92/96)	09.7382 ●	GU28743701/61	12V CC - coppia trombe	55
750 X Polizia	09.7386 ●	GU30743700	12V CC - zincato	56
850 Le Mans I/II/III (81/84)	09.7386 ●	GU14743700	12V CC - zincato	56
850 T/T3/Base/California/T4	09.7383 ●	GU14743700/01	12V CC - coppia	55
850 T5 Civile III Serie/Polizia/C.C./P.A.	09.7382 ●	GU28743701/61	12V CC - coppia trombe	55
850 V7 Eldorado/GT/California (72/>)	09.7386 ●	25743701	12V CC - zincato	56
1000 California II/III/Carb./IE (81/93)	09.7382 ●	GU29743752/53	12V CC - coppia trombe	55
1000 V I-Convert (75/84)	09.7383 ●	GU14743700/01	12V CC - coppia	55
1000 Daytona/Racing (92/96)	09.7386 ●	GU30743700	12V CC - zincato	56
1000 G5 (78/85) • 1000 SP (79/84)	09.7383 ●	GU14743700/01	12V CC - coppia	55
1000 GT • Le Mans • Quota • 1000 S	09.7382 ●	GU28743701/61	12V CC - coppia trombe	55
1000 SP II/III (84/94) • 1100 Quota ES (99/02)	09.7382 ●	GU28743701/61	12V CC - coppia trombe	55
1000 Strada • 1100 Sport Carburatori	09.7386 ●	GU30743700	12V CC - zincato	56

## MOTO MORINI

100 Sbarazzino T/GT/SS • 125 H Strada	09.7387 ●		6V CC - zincato	56
125/150 Corsaro T/GT/SS/SL/Country	09.7387 ●		6V CC - zincato	56
250 T Monocilindrico • 250 GT/Settebello	09.7387 ●		6V CC - zincato	56
250 J Bicil. • 350 3 1/2 • 500 Strada/Sport	09.7345 ●	460203	12V CC - nero	55
350/501 Kanguro/Camel/X2 (Avv. elettr.)	09.7345 ●	460272	12V CC - nero	55
350/501 Coguar/New York/Excalibur	09.7345 ●	460272	12V CC - nero	55
350/501 Excalibur RLX	09.7383 ●	460693/460394	12V CC - coppia	55
350/400 Dart	09.7345 □	80A050555	12V CC - nero	55

Applicazione	Cod. SGR	Rif. originale / Note	Caratteristiche tecniche	Fig. pag.
<b>PEUGEOT</b>				
50 Buxy • 50 Fox • 50 Metropolis • 50 Rapido/ST	09.7391 ●	734847	12V CC - nero	56
50 Elystar • 50 JetForce • 50 MetalX • 50 XRace	09.7391 ●	734847	12V CC - nero	56
50 Ludix • 50 Speedake • 50 Squab • 50 Zenith	09.7391 ●	734847	12V CC - nero	56
50/100 Elyseo • Looxor • Speedfight/2-SV Geo	09.7391 ●	734847	12V CC - nero	56
50/100 Trekker/TKR/2 • Vivacity • X-Fight	09.7391 ●	734847	12V CC - nero	56
125/150 Elyseo • Elystar • Jet Force	09.7522 ●	741050	12V CC - nero	57
125/150 Looxor • 125 SV Geo	09.7391 ●	734847	12V CC - nero	56
250 SV	09.7535 ●		12V CC - nero	58

## PIAGGIO CICLOMOTORI-SCOOTER

50 Boss Boxer • Bravo • SuperBravo • Ciao Si • Grillo	09.7347 ●	580529	6V-15W CA nero	54
50 Free/FL (92/02) • 50 Sfera/Maq2/Rst (91/97)	09.7516 □	CM071803	12V CC	57
50 Liberty 2t/4t/Rst/Sport (97/07)	09.7516 □	CM071803	12V CC	57
50 NRG Power DD/DT (06/10)	09.7516 □	CM071803	12V CC	57
50 Typhoon (01/09)	09.7516 □	CM071803	12V CC	57
50 Vespa ET2/IE • 50/100/125 Zip tutti	09.7516 ●	58034R	12V CC	57
125/150 Skipper/LX 2t/ST 4t • 125 Sfera 4T	09.7516 □	CM071803	12V CC	57
125/150 Vespa ET4/LX//LXV/S/IE	09.7516 ●	58034R	12V CC	57
125/150/200 Liberty/Rst/4T/Sport (98/07)	09.7516 □	CM071803	12V CC	57
125/180/250 Hexagon/SuperHexagon 2t/4t	09.7516 ●	58034R	12V CC	57
125/200 Beverly (01/03) • 500 Beverly (02/04)	09.7516 ●	58034R	12V CC	57
125/250/300/400 MP3/LT/MIC	09.7516 □	CM071803	12V CC	57

## PIAGGIO VESPA-APE

50 Ape (69/80) • 50 Ape P (80/85 - TL3)	09.7331 ●	123676	6V-24W CA nero	54
50 Ape P (84/85 - TL3 elettronico - c/avv.to)	09.7393 □	CM071807	12V CC	56
50 Ape TM P (85/89 - c/avv.to elettrico)	09.7393 □	CM071807	12V CC	56
50 Ape FL/FL2/FL3/Rst MIX/Euro 2 (89/10)	09.7393 □	CM071807	12V CC	56
50 Vespa N/L/R (63/83)	09.7331 ●	123676	6V-24W CA nero	54
50 Vespa S/SS/Special	09.7331 ●	580223	6V-24W CA nero	54
50 Vespa PK/S/Automatica (s/avv.to)	09.7331 ●	216443	6V-24W CA nero	54
50 Vespa PK S/Automatica (c/avv.to)	09.7331 ●	216443	6V-24W CA nero	54
50 Vespa PK SS (s/avv.to)	09.7337 □	189380	12V-45W CA - zincato	54
50 Vespa PK XL/Rush/Plurimatic (c/avv.to)	09.7501 □	293293	12V CC - nero	57
50 Vespa N/FL/FL2 HP/Automatica (c/avv.to)	09.7501 □	293293	12V CC - nero	57
90 Vespa/SS SuperSprint/Racer	09.7331 ●	580223	6V-24W CA nero	54
125 Vespa/Primavera/ET3 (65/>)	09.7331 ●	580223	6V-24W CA nero	54
125 Vespa P ETS (c/avv.to)	09.7501 □	293293	12V CC - nero	57
125 Vespa GT/GTR/Super/TS (s/batteria)	09.7331 ●	580223	6V-24W CA nero	54
125 Vespa PK (s/frecce)	09.7331 ●	215873	6V-24W CA nero	54
125 Vespa PK S/S Automatica (s/avv.to)	09.7337 □	189380	12V-45W CA - zincato	54
125 Vespa PK S Automatica (c/avv.to)	09.7393 □	CM071807	12V CC	56
125 Vespa PK XL/FL (c/avv.to)	09.7501 □	293293	12V CC - nero	57
125/150/200 PX/PE/PX-E (77/83 - s/frecce - 6V)	09.7331 ●	070300	6V-24W CA nero	54
125/150/200 PX/PE/PX-E (77/83 - s/frecce - 12V)	09.7340 ●	189379	12V-45W CA nero	54
125/150/200 PX/PE/PX-E (77/83 - c/frecce - s/batt.)	09.7340 ●	189379	12V-45W CA nero	54
125/150/200 PX/PE/PX-E (77/83 - c/frecce - c/batt.)	09.7393 □	264094	12V CC	56
125/150/200 PX-E Arcobaleno (s/avv.to)	09.7340 ●	189379	12V-45W CA nero	54
125/150/200 PX-E Arcobaleno (c/avv.to)	09.7393 □	264094	12V CC	56

Applicazione	Cod. SGR	Rif. originale / Note	Caratteristiche tecniche	Fig. pag.
125/150/200 Vespa PX (98/01)	<b>09.7393</b> □	CM071807	12V CC	56
125 Vespa PX Euro 2 (98/06)	<b>09.7393</b> □	58144R	12V CC	56
125 Vespa PX 30 Anni (07/08)	<b>09.7393</b> □	58144R	12V CC	56
125/150 Vespa PX (11)	<b>09.7393</b> □	58144R	12V CC	56
150 Vespa Sprint/Veloce/Super (s/batt.)	<b>09.7331</b> ●	097828	6V-24W CA nero	54
180/200 Vespa SS/Rally (s/batt.)	<b>09.7331</b> ●	097828	6V-24W CA nero	54
220 Ape Car P2/P3 • Ape MP P501/P601/V	<b>09.7518</b> □	292695	12V CC	57
220 Ape TM P602/P703/V/FL	<b>09.7518</b> □	292695	12V CC	57
420 Ape Poker/Car/Max/Diesel	<b>09.7518</b> □	292694	12V CC	57
420 Ape TM P703/V/FL Diesel	<b>09.7518</b> □	292695	12V CC	57

## SUZUKI

50 AP Address • 50 CP/Lido				
50 AJ/Tune/Sepia ZZ	<b>09.7391</b> ●		12V CC - nero	56
50 Katana/LC • 125/150 AN	<b>09.7391</b> ●		12V CC - nero	56
125/150/250/400 Burgman • 125/150 Epicuro	<b>09.7522</b> ●		12V CC - nero	57
400 DR (80/81) • 500 DR (83/84)	<b>09.7390</b> ●	38500-37280	6V CC - zincato	56
400 GS C/EC (78)/N/EN (92)	<b>09.7522</b> ●	38500-64130	12V CC - nero	57
450/500/550 GS/GS-E (80/88)	<b>09.7522</b> ●	38500-34230	12V CC - nero	57
600/650 DR R/S	<b>09.7522</b> ●		12V CC - nero	57
650 GS G (82/83) • 750 GS (78)	<b>09.7522</b> ●	38500-34230	12V CC - nero	57
750 GSX-R (91) • 1100 GSX-R (91/92)	<b>09.7522</b> ●	38500-64130	12V CC - nero	57
850 GS G (86) • 1000 GS • 1100 GSX	<b>09.7383</b> ●		12V CC - <u>coppia</u>	55

## YAMAHA

50 Axis • 50 Breeze 50 • CT 50 S/SS • 50 CR Z	<b>09.7391</b> ●	4CU-H3371-00	12V CC - nero	56
50 BW'S/Original/Next Generation/R/L	<b>09.7391</b> ●	5SB-H3371-00	12V CC - nero	56
50 Neos 4t (10/11) • 50 Jog • 50 Slider	<b>09.7391</b> ●	4CU-H3371-00	12V CC - nero	56
50/100 Aerox • 50/100 Neos	<b>09.7391</b> ●	5SB-H3371-00	12V CC - nero	56
50 TZR/RR (03/11)	<b>09.7391</b> ●	4CU-H3371-00	12V CC - nero	56
125/250 DT (79/81)	<b>09.7390</b> ●	3Y1-83371-10	6V CC - zincato	56
125 DT LC (Belgarda)	<b>09.7387</b> ●		6V CC - zincato	56
125 DT Ténére (YPVS)	<b>09.7345</b> ●	2VN-H3371-V0	12V CC - nero	55
125 DT R (89/00) • 125 SR • 125 TW	<b>09.7530</b> ●	2KG-83371-00	12V CC - zincato	58
125 DT X/RE (05/06) • 125 YZF-R (08/11)	<b>09.7522</b> ●	1D0-H3371-00	12V CC - nero	57
125 TDR/R • 125 TZR/RR (Belgarda)	<b>09.7522</b> ●	4SU-H3371-00	12V CC - nero	57
125 Cygnus • 150 Fly One	<b>09.7391</b> ●	4CU-H3371-00	12V CC - nero	56
125/150 Maxster • 125/150 Teo's	<b>09.7535</b> ●	2KG-83371-00	12V CC - nero	58
125/150/180 Majesty	<b>09.7522</b> ●	5DS-H3371-00	12V CC - nero	57
125/250 X-City • 125/250 X-Max	<b>09.7522</b> ●	1S6-H3371-00	12V CC - nero	57
125/250 XV Virago	<b>09.7535</b> ●	2KG-83371-00	12V CC - nero	58
250 XT (81/83) • 500 XT (76/79)	<b>09.7390</b> ●	3Y1-83371-10	6V CC - zincato	56
250 Majesty/DX (98/00)	<b>09.7535</b> ●	2KG-83371-00	12V CC - nero	58
250 Majesty (00/06)	<b>09.7522</b> ●	5GM-83371-00	12V CC - nero	57
250 WR-F (01/08) • 400/426/450 WR-F (98/08)	<b>09.7522</b> ●	4SU-H3371-00	12V CC - nero	57
300 Versity/XC • 400 Majesty	<b>09.7522</b> ●	1S6-H3371-00	12V CC - nero	57
600 XT E (90/>) • 600/900 XJ N/S Diversion	<b>09.7535</b> ●	2KG-83371-00	12V CC - nero	58
600/1000 FZS Fazer	<b>09.7535</b> ●	2KG-83371-00	12V CC - nero	58
750 XTZ Superténére • 850 TDM	<b>09.7535</b> ●	2KG-83371-00	12V CC - nero	58
1000 YZF R1 (98/05)	<b>09.7535</b> ●	2KG-83371-00	12V CC - nero	58

## Claxon corrente alternata

**09.73181** claxon nero 6V-18W Ø 75 - attacco faston c/staffa

**09.732211** claxon zincato bianco 6V-18W Ø 75 - attacco faston - c/staffa

Appr.: DGM 44211-IGM 0785 KMA



Adattabili su:

**ciclomotori vari** c/imp. 6V-A.C.

**09.7331** claxon nero 6V-24W Ø 75 - attacco faston

Appr.: DGM 44211-IGM 0785 KMA

Adattabile su:

**Piaggio** 50 Vespa S/SS/Sprinter • 50 Vespa Special • 50 Vespa PK/S (82/85 - s/avv.to)  
90 Vespa/S/SS/Racer • 125 Vespa/Primavera (65/83) • 125 Vespa ET3 • 125 Vespa GT/GTR  
125 Vespa Super • 125 Vespa TS • 125 Vespa PK (82/85) • 125/150 Vespa P-X (s/frecce)  
125/150/200 Vespa PX-E (s/frecce) • 150 Vespa Sprint/Sprint Veloce • 150 Vespa Super  
150 Vespa P-S (s/frecce) • 180/200 Vespa Rally • 200 Vespa P-E (s/frecce)  
50 Ape (69/80)/P (80/85 - acc. puntine)

Rif. orig.: 216443 • 580223 • 215873 • 123676 • 070627 • 098458 • 097828 • 070300



**09.7337** claxon zincato bianco 12V-45W Ø 72 - attacco faston

Appr.: DGM 36416 KMA



Di primo equipaggiamento su:

**Piaggio** 50 Vespa PK SS (83/> - s/avv.to)  
125 Vespa PK S (82/85 - c/frecce - s/avv.to)  
125 Vespa PK S Autom. (84/89 - s/avv.to)

Rif. orig.: 580312 • 189380

**09.7347** claxon nero 6V-15W Ø 75 - attacco faston

Appr.: DGM 44211-IGM 0785 KMA



Adattabile su:

**Piaggio** 50 Boss (88/89 - s/frecce) • 50 Boxer 1/2 (70/82)  
50 Bravo/R2/EVL/3 (75/90) • 50 Ciao Special/R/SC/Arcobaleno (69/81)  
50 Ciao R2/SC (75/81) • 50 Ciao P/PX/PXV (80/88)  
50 Ciao FL (88/>) • 50 Ciao Mix Teen (96/01) • 50 Ciao Euro 1/Euro 2  
50 Grillo (s/frecce) • 50 Si/FL/FL2/Mix (79/99 - s/frecce)  
50 SuperBravo/3 (85/>)

Rif. orig.: 188123 • 580529

**09.7340** claxon nero 12V-45W Ø 75 - attacco faston

Appr.: DGM 44211-IGM 0785 KMA



Adattabile su:

**Piaggio** 125/150 Vespa P-X (c/frecce - s/batt.)  
125/150/200 Vespa PX-E (c/frecce - s/batt.)  
125/150/200 Vespa PX-E (81/97 - s/avv.to)  
150 Vespa P-S (c/frecce) • 200 Vespa P-E (c/frecce - s/batt.)

Rif. orig.: 189379 • 163599

**09.7504** claxon nero 12V-28W Ø 75 - attacco faston - c/staffa

Appr.: DGM 44211-IGM 0785 KMA



Adattabile su ciclomotori vari imp. 12V/C.A.:

**Aprilia** ET 50 (AE) • Tuareg 50 (AE - 87)  
AF1 50 (AE) • ETX 50 (85/86)  
**Malaguti** RST 50 (AE)  
Fifty 50 HF/Top/RV/Full CX/Up/Evolution (88/97) • 50 JX  
50 Dune • 50 MRX/MGX/MEX/MFX/MDX/Gold

Rif. Aprilia: 82.12.117 • 82.12.064

Rif. Malaguti: 018.014.00

## Claxon e trombe corrente continua

**09.7345** claxon nero 12V - 4A/114dB - Ø 90 - attacco faston - c/staffa - tonalità bassa 340 Hz

Appr.: (E3) 0051344  
(E3) CH 2105



### Di primo equipaggiamento su:

**Cagiva** 50 Prima • 125 Aletta Oro GP S2 (alternativo)  
125 Cruiser • 125 Elefantre • 125 Freccia C9/C10R/C12R  
125 Mito (01/06) • 125 N90 • 125 Raptor (alternativo)  
125 Roadster • 125 Tamanaco • 350/500 T4-E • 350/650/750 Elefant  
**Ducati** 350/650/750 Indiana • 750 Sport (88/90)  
**Moto Morini** 350/400 Dart

### Adattabile su:

**moto varie** impianto 12V  
**Ducati** 350/400 F3 • 350/500 GTL/GTV/Desmo  
350/500/600/650 Pantah/XL/TL/SL • 750 F1 Pantah/Desmo/Montjuich  
750 F1 Laguna Seca/Santamonica • 750 Paso • 750/900 SS Desmo  
860/900 GT/GTS • 900 SD/SSD/S2/Desmo/Darmah/MHR  
1000 MHR Replica/S2/Desmo  
**Laverda** 750 S/S Carenato (97/98) • 750 S Formula/S Sport (98/00)  
750 Strike Monofaro/Bifaro (98/99)  
**Moto Morini** 250 J Strada Bicilindrico • 350 3 1/2 Strada/Sport  
500 Strada/Sport • 350 Kanguro/X2 avv. elettrico • 350 New York  
350/501 Cougar • 350/501 Excalibur • 501 Camel/X2 avv. elettrico

Rif. Cagiva: 800A0512 • 80A050555  
Rif. Ducati: 037038050 • 036138050

Rif. Laverda: 076005000004  
Rif. Moto Morini: 80A050555 • 460272

**09.7382** coppia trombe bitonali cromate 12V c/relé - attacco faston - Ø 90  
Appr.: (E3) 37913

### Di primo equipaggiamento su:

**Cagiva** 125 SST Low Rider

### Adattabile su:

**moto varie** impianto 12V  
**Moto Guzzi** 350/650 V35 Florida/V65 Florida  
350/650 35 GT/65 GT • 1000 California II/III/Carb./IE (81/93)  
**Moto Morini** 250 J Strada Bicilindrico • 350 3 1/2 Strada/Sport • 500 Strada/Sport  
Rif. Guzzi: GU29743752/53



**09.7383** coppia claxon zincati bianchi 12V - 4A/114dB - Ø 90 - attacco faston - c/staffa - tonalità bassa 340 Hz + tonalità alta 430 Hz  
Appr.: (E3) 0051344/ (E3) CH 2104

### Adattabile su:

**Benelli/Ducati** moto varie (impianto 12V - coppia)  
**Kawasaki** 500 GPZ S (87/03) • 550 KZ Spectre/LTD Shaft (82/84)  
550 GPZ (82/86) • 750 KZ (83) • 750 GPZ/Turbo (82/85)  
1100 GPZ (83/84)  
**Laverda** 668 650 Sport/Formula (94/95) • 668 Diamante (96/98)  
668 Ghost/Strike/Legend (96/98) • moto varie (impianto 12V - coppia)  
**Moto Morini** 350/501 Excalibur RLX  
**Suzuki** 850 GS G (86) • 1000 GS C/EC/HC (78)  
1000 GS N/EN/HN (92) • 1100 GSX T/X/ET/EX (80/81)  
**Yamaha** 500 T-Max  
**Moto varie** impianto 12V



### Di primo equipaggiamento su:

**Cagiva** 125 Blues  
**Moto Guzzi** 750 V7 Sport • 750 S • 850 T (USA - Germania)  
850 T3/California (79/85) • 1000 SP (79/84)

Rif. Cagiva: 800058975/976  
Rif. Benelli: 76502015/16 • Rif. Ducati: 079538053  
Rif. Kawasaki: 27003-1263 • 27003-1057/58

Rif. Laverda: 076005000002  
Rif. Moto Morini: 460693 • 460394  
Rif. Moto Guzzi: GU14743700/01

**09.7386** claxon zincato bianco 12V - 4A/114dB - Ø 90 - attacco faston - c/staffa - tonalità bassa 340 Hz - c/condensatore  
 Appr.: (E3) 0051344/ (E3) CH 2104

Di primo equipaggiamento su:

**Cagiva** 125 Aletta Oro S1/GP S2 • 125 Cruiser (alternativo)  
 125 Cucciolo • 125 Elefant 2 • 125 Elefantre (alternativo)  
 125 Mito/Racing/EV/Euro 2 (94/06) • 125 Planet • 125 Raptor  
 125 SXT (82/>) • 125 Supercity • 125 WSXT Aletta Rossa • 200 Elefant  
 250/350 Ala Blu • 250/350 Ala Verde • 250/350 SST • 250/350 SX  
 350 Ala Rossa • 350 W12 • 350/500 T4-E (alternativo)  
 350/650/750 Elefant (alternativo) • 500 W16 • 500/600 Canyon/River  
 900 Elefant • 900 Grand Canyon

**Casalini** Sulky • David

**Ducati** 400 Monster (95/03) • 400 SuperSport (93/97)  
 600 Monster (93/01) • 600 SuperSport (91/97) • 620 Sport (03)  
 748/Bip./SP/R/S/SPS (95/02) • 750 Monster (96/01) • 750 Sport (01/02)  
 750 SuperSport/IE (91/02) • 800 Sport (03) • 800 SuperSport (03/07)  
 851 SuperBike • 888 SP5/SuperBike • 900 Monster/IE (93/01)  
 900 SuperSport/IE (91/02) • 900 Sport (02) • 916 SP/Bip./Senna (94/98)  
 916 ST4 (99/02) • 944 ST2 (97/03) • 996 916 SPS (97/98)  
 996/R/S/SPS/II/III (99/01) • 996 ST4S/ABS (01/05) • 998 (02/04)  
 1000 ST3/S/ABS (05/07) • 1000 SuperSport (03/06) • 1098/S (07)

**Moto Guzzi** 350/500 V35/V50 (acc. elettronica - 77/79)

850 Le Mans III (81/84)

**Moto Morini** 350/400 Dart (alternativo)

Rif. Aprilia: AP8112201

Rif. Benelli: 27743715 • 65743700

Rif. Ducati: 5164011AB

Rif. Gilera: 328038 • 322821



Adattabile su:

**moto varie** impianto 12V

**Aprilia** 125 ETX (85/87) • 125 ST • 350/600 ETX (85/86)

**Benelli** 125 BX • 125 Jarno • 254 • 350 RS • 354 • 500 LS  
 504 • 650 Tornado • 750/900 SEI

**Gilera** 125 XR1/XR2 • 125 RX/RV • 125 KK/KZ • 350 Dakota • 350 T4

**Laverda** 600 OR Atlas

**Moto Guzzi** 125 Custom • 254 • 350 RS • 354 • 500 LS • 504

350/650/750 NTX • 750 Strada • 750 X Polizia

1000 Daytona/Racing (92/96) • 1000 Strada • 1100 Sport Carburatori

Rif. Laverda: 76502031

Rif. Moto Guzzi: GU14743700 • GU30743700 • GU27743715

GU66743720 • GU65743700

Rif. Moto Morini: 5164011AB

**09.7387** claxon zincato bianco 6V - 4A/114dB - Ø 90 - attacco faston  
 c/staffa - tonalità alta 430 Hz

Appr.: (E3) 0051344/ (E3) CH 2104



Di primo equipaggiamento su:

**Honda** CB 125 S/X/Endurance • CS 125

**Malaguti** 125 Runner (YLC)

**Yamaha** DT 125 LC (Belgarda)

Adattabile su:

**Ducati** 160 Monza Junior • 160 Turismo/Sport

200 Turismo/Elite • 250 Road/Deluxe/24 H/Monza

250/350/450 Scrambler/Mark 3/Desmo • moto varie

**Moto Guzzi/Benelli/Moto Morini** varie imp. 6V/C.C.

Rif. Benelli/Guzzi: 39743700

Rif. Ducati: 012038053

Rif. Honda: 38110-KY0-970

Rif. Malaguti: 018.007.00

**09.7391** claxon nero 12V Ø 65 - attacco faston - c/staffa

Appr.: DGM 50686 KM

(E3) 48240



Adattabile su:

**Aprilia** scooter 50/100

**Benelli** scooter 50/100

**Betamotor** scooter 50

**Cagiva** scooter • moto varie

**Italjet** scooter 50/100

**Kawasaki** moto varie

**Kymco** scooter 50

**Malaguti** scooter 50/100

**MBK** scooter 50/100

**Peugeot** scooter 50/100/125

**PGO** scooter 50

**Rizzato** scooter 50

**Suzuki** scooter 50/125/150

**Yamaha** scooter 50/100/125

**09.7390** claxon zincato bianco 6V - 3A/105-118dB - Ø 70  
 attacco faston - c/staffa

Appr.: (E3) 50097/ (E3) 53928



Adattabile su:

**moto varie** impianto 6V - D.C.

**Honda** XL 125 S/SD • XL 250 S/R • XL 500 S/R

**Yamaha** XT 500 • **Suzuki** DR 400/500

Rif. Honda: 38110-435-771

Rif. Yamaha: 1N5-83371-20

**09.7393** claxon zincato bianco 12V Ø 75 - attacco faston - c/doppia flangia

Appr.: (E3) 57759

(E9) 01-1143



Di primo equipaggiamento su:

**Piaggio** 125 Vespa PK S Autom. (84/89 - c/avv.to)

125/150 Vespa P-X (c/freccie - c/batt.)

125/150/200 Vespa PX-E (c/freccie - c/batt.)

125/150/200 Vespa PX-E (81/97 - c/avv.to)

125/150/200 Vespa PX (98/01) • 125/200 Vespa PX Euro 2 (98/06)

200 Vespa P-E (c/freccie - c/batt.) • 50 Ape TM P (85/89 - c/avv.to)

50 Ape FL/FL2/FL3 Europa (89/99) • 50 Ape Rst Mix (99/05)

Rif. orig.: CM071807 • 264094



**09.7500** claxon nero 12V - 4A/114dB - Ø 90 - attacco faston - c/staffa  
 tonalità alta 430 Hz  
 Appr.: (E3) 0051344/ (E3) CH 2105



Di primo equipaggiamento su:

**Aprilia** Classic 125 • AF1 125  
 Red Rose 125 • Tuareg 125 Rally  
 RX 125 (89/94) • Pegaso 600/650 (90/96) • RSV 1000 (98/00)  
 Rif. orig.: AP8124747 • AP8112500

**09.7501** claxon zincato bianco 12V - 3A/105-118dB - Ø 70  
 attacco faston - c/staffa

Appr.: DGM 50686 KM  
 (E3) 48240



Di primo equipaggiamento su:

**Piaggio** Vespa PK 50/125 XL Plurimatic (c/avv.)  
 PK 50 XL (c/avv.)/PK 50 XL Rush (c/avv.)  
 P 125 ETS (c/avv.)/PK 125 XL (c/avv.)/  
 PK 50 FL (c/avv.)/PK 50 FL2/HP/Automatica (c/avv.)/  
 PK 50 N (c/avv.)/PK 50 XL Rush (c/avv.)/PK 125 FL (c/avv.)  
 Rif. orig.: 293293 • 231320

**09.7516** claxon zincato bianco 12V - 3A/105-118dB - Ø 70 - attacco faston - c/staffa - c/filettatura Ø 5 mm.

Appr.: (E3) 50097  
 (E3) 53928



Di primo equipaggiamento su:

**Aprilia** Scarabeo Light 250/300/400/500 (06/10)  
**Gilera** 50 Easy Moving • 50 Runner/SP/Poggiali (97/04)  
 50 Stalker • 50 Storm • 50 Typhoon/X/XR • 125/250/300/500 Nexus  
 125/180 Runner FX/FXR/SP 2T • 125/180/200 Runner VX/VXR 4T  
**Piaggio** 50 Free/FL (92/02)  
 50 Liberty 2T/4T/RST/Sport/Moc/Elle (97/10)  
 50 NRG Power DD/DT (06/10) • 50 Typhoon (01/09) • 100 Free  
 125 Sfera FL (95/97) • 125/150 Skipper LX 2T/ST 4T (98/>)  
 125/150/200 Liberty/RST/4T/Sport (98/07) • 250 MP3  
 125/300/400 MP3

Rif. Aprilia/Piaggio/Gilera: AP8127834 • 58034R • CM071801 • CM071803 • 293350 • 293292 • 294829 • 291230 • 293595 • 291845  
 58003R • 58030R • 580988 • 294828

Adattabile su:

**Piaggio** 50 Sfera/Maquillage 2/RST (91/97)  
 50 Vespa ET2/IE  
 50 Zip Base/RST/Fast Rider/RST (92/99)  
 50 Zip SP (96/99) • 50 Zip Cat. 2T (00/04)  
 125 Hexagon LX4 4T • 125 Zip  
 125/150 Hexagon 2T • 125/150 Skipper (94/97)  
 125/150 Vespa LX/Euro 3/LXV (05/07) • 125/150 Vespa ET4  
 125/180 Hexagon LX/LXT 2T • 125/180 Hexagon GTX 4T  
 125/180 SuperHexagon GTX 4T • 125/200 Beverly (01/03)  
 250 Hexagon GT • 250 SuperHexagon GTX • 500 Beverly (02/04)

**09.7518** claxon zincato bianco 12V - 4A/114dB - Ø 90 - attacco faston  
 c/staffa  
 Appr.: (E3) 45905-45906  
 (E3) CH 2105



Di primo equipaggiamento su:

**Piaggio** Ape Car P2/P3 • Ape MP P501/P601/V  
 Ape TM P602/703/V/FL2 • Ape Poker • Ape TMP 703 Diesel  
 Ape Car Max Diesel  
 Rif. orig.: 292694 • 292695

**09.7520** claxon "**Leonelli**" ottonato 12V - 1,5A/100±5dB - Ø 65  
 attacco faston - c/staffa

Appr.: (E9) 01-1133  
 (E9) 4004



Di primo equipaggiamento su:

**Aprilia** Scarabeo 50 (Mot. Minarelli - 98/06)  
 Scarabeo 50 Di-Tech • Scarabeo 50 4T/4T-4V/Net (01/11)  
 Scarabeo 100 2T/4T • Scarabeo 50 2T/Net (mot. Piaggio - 05/11)  
 Rif. orig.: AP8224038

**09.7522** claxon nero 12V - 1,2A/110-118dB - Ø 80 - attacco faston - c/staffa

Appr.: (E3) 57757

Adattabile su:

scooter 125/150/250/400  
**Aprilia • Benelli • Beta • Honda • Kymco • Malaguti • MBK • Peugeot • Suzuki • Yamaha**  
 moto **Honda • Suzuki • Kawasaki • Yamaha**



**09.7530** claxon zincato bianco 12V - 3A/105-118dB - Ø 70 - attacco faston - c/staffa

Appr.: (E13) 50097/53928

Di primo equipaggiamento su:

**Malaguti** 50 Centro SL Cat. (99/00) • 50 Ciak/TD/Euro 2/2.3/Master 2T (99/06) • 50 Crosser • 50 Yesterday  
50 F10/RST/Euro 1/2/2.3 (92/06) • 50 F12 Air/LC/RST/Euro 1/2/2.3 (94/06)  
50 F15 Air/LC/RST/Euro 1/2/2.3 (96/06)  
100 Ciak • 100 F12 • 125 Ciak/Master/Euro 2/Euro 3 (00/06) • 125 Madison/R/RST/Euro 2 (99/05)  
125/150 F18 Warrior • 125/200/250 Phantom Max • 150 Ciak/Master/Euro 2 (00/05) • 150/180/200 Madison  
200 Ciak Master Euro 2 (06) • 250 Madison S/RS RST (99/05) • 400 Madison • 500 SpiderMax GT

Rif. orig.: 01805400



**09.7535** claxon "**Mitsuba**" nero 12V - 3,5A/110dB - Ø 70 mm. - c/staffa - attacco faston - tonalità bassa

Appr.: (E13) 000514

Adattabile su:

**moto varie** impianto 12V

**Honda** 125/150 Pantheon 2T (98/02) • 250 Foresight (00/05)  
650 NT V Deauville (98/05) • 650 NX Dominator (97/99) • 650 SLR

Rif. Honda: 38120MAK003 • 38120MBZK00

Di primo equipaggiamento su:

**Honda** 600 CB F Hornet/S (01/06)  
900 CB F Hornet (02/06)



## Segnalatori acustici

**09.73792** segnalatore acustico Ø 49 - 12V - c.c. - c/staffa - c/cavi



Adattabile su:

**tutti gli scooter, moto e macchine agricole**

Sostituisce: 09.7379

**09.6010** avvisatore retromarcia "**Mitsuba**" Ø 44 c/staffa  
funzionamento a 12/24/36/48V - C.C.  
intensità sonora 85 +/- 10 Db (1 metro)  
frequenza 3.000 +/- 500 Hz  
frequenza impulsi 90 +/- 30 colpi/minuto



Adattabile su:

**Universale** auto • moto • camion con impianti da 12 a 48 volt

Sostituisce Nippondenso 60.1010

**60.1011** avvisatore retromarcia Ø 50 - 24V - c.c. - "**Denso**"



Adattabile su:

**auto, autocarri, trattori, muletti e macchine movimento terra**

## Intermittenze

**02.7735** intermittenza elettronica universale 12V  
max 20A (240W) - c.c. - 2 faston medi - c/gommino a corredo



Adattabile su:

**moto e scooter vari** imp. 12V c/intermittenza a 2 faston

**02.7752** intermittenza 6V - wattaggio universale - 15-108W - 3 faston medi - c/staffa - adattabile

**02.7753** intermittenza 12V - wattaggio universale - 15-138W - 3 faston medi - c/staffa - adattabile

**02.7756** intermittenza 24V - wattaggio universale - 15-200W - 3 faston medi - c/staffa - adattabile

Adattabile su:

**applicazioni varie • moto • scooter • motocarro**

**02.7754** intermittenza 12V - wattaggio universale - 23-138W - 2 faston medi - adattabile

Adattabile su:

**Kawasaki** H1/Mach III • H2 Mach IV • KH 250/400/500 • KZ 550/650/750

GPZ 750 (83/85) • GPZ 900 (84/86) • KZ 1000/1100/1300

ZX 1000 R (86/87) • GPZ 1100 (83/84)

**Cagiva** SST 125 • SST 250/350 Ala Verde • SX 250/350 Ala Blu • 350/4T Ala Rossa

**Aprilia** Amico 50 • Gulliver 50 H<sub>2</sub>O • ET 50 • Tuareg 50 • AF1/50 • RS 50 (93/95)

RS 50 (99/01 - Italia) • ETX 125 • Tuareg 125 • RS 250 (95/01) • ETX 350

Tuareg 350 Wind • RSV 1000 (98/00 - Europa)

**Malaguti** Centro 50 Base/SL (93/98) • Crosser 50 • 50 F10 (92/98) • 50 F12 (94/98) • JX 50 (91/92)

Fifty 50 Top/Up/HF/Full CX/Evolution

**Guzzi • Laverda • Morini • Rizzato**

Rif. *Aprilia*: AP8112795

Rif. *Cagiva*: 26153

Rif. *Kawasaki*: 27002-011/016

Rif. *Malaguti*: 02501900

**02.7764** intermittenza 12V - wattaggio universale - 23-138W  
3 faston medi - adattabile



Adattabile su:

**ciclomotori, moto varie e applicazioni agricole**

**02.7736** intermittenza elettronica universale 12V  
max 20A (240W) - c.c. - 3 faston medi - c/gommino a corredo



Adattabile su:

**moto e scooter vari** imp. 12V c/intermittenza a 3 faston



**02.7966** intermittenza 6V - wattaggio universale - 23-108W  
3 faston medi - adattabile



Adattabile su:

**moto c/impianto a 6V**

**Piaggio** Vespa tutti i tipi (ricambio per kit frecce)

- 02.7761** intermittenza elettronica "Mitsuba" 12V - 10Wx2+3,4W - c.c. - 2 faston medi - c/supporto (Mitsuba FR-2201)  
**02.77611** intermittenza elettronica "Guilera" 12V - 10Wx2+3,4W - c.c. - 2 faston medi - c/supporto - (tipo Denso)  
**02.776117** intermittenza elettronica 12V - 10Wx2 - c.c. - 2 faston medi - c/supporto - adattabile (tipo Mitsuba)

Di primo equipaggiamento su:

**Aprilia** Amico 50 (96/>) • Area 51 • Gulliver Air • Rally/LC • Scarabeo 50/Ditech • SR 50/Ditech • Sonic 50/LC RS 50 (96/98) • RS 50 (99/05) • RS 50 Tuono (03/04) • RX 50 • ETX 50/125 • Habana 50/Custom • Classic 50/125 RS 125 (</05) • Leonardo 125/150/250 • Scarabeo 100/125/150/200 • SR 125/150 • Pegaso 650 • SL 1000 Falco RST 1000 Futura • ETV 1000 Caponord • RSV 1000 (98/03 - USA) • RSV 1000 (91/03) • RSV 1000 Tuono (02/05) Atlantic 500 Sprint (05/>) • RXV/SXV 450/550  
**Cagiva** WSXT 125 Aletta Rossa • SXT 125 • Elefant 125/200  
**Gilera** RV 125/200 • KK/KZ 125 • RV 250 NGR • MX1/125 • SP 01/02 125 • XR1/XR2 125 • R1/R1 S 125 XRT 350/600 • Easy Moving • Eaglet • Stalker 50 (</04) • Typhoon 50/125 (</97) • Storm 50 (94/95) • GSM 50  
**Honda** XL 125 R/PD • MTX 125 R (83) • NS 125 F/R • Vision SP (90/91) • Sky 50 • NH 80 • Lead 80 • SXZ 50 SH 50/75/Fifty • SFX 50 • CRM 50/75 • NX 125 (89/99) • CG 125 (93/00) • CRM 125 R (90/99) NSR 125 F (88/93) • NSR 125 R (89/01) • XL 125 V Varadero (01/06)  
**Malaguti** Ciak 50 2T (99/06) • CNK 50 • 50 F10 (92/06) • 50 F12 (94/06) • 50 F15 (96/06) • XTM/XSM 50 100 F12 • Ciak 100 • Madison 125/150 (99/02) • Ciak 125/150/200 (99/06) • Madison 250 (99/03) Madison 400 • 125 F12 Max (03/>)  
**Piaggio** Ape 50 FL/FL2 (89/95) • Free 50/FL (92/02) • Free 100 • NRG 50/MC<sup>2</sup> (94/98) • 50 NTT • 50 Sfera/FL Vespa 50 ET2 Iniez. • Vespa PK 50 FL2 HP • Zip 50 Base/RST/FR/RST (92/99) • Zip 50 SP (96/00) Sfera 125 • Hexagon 125/150/180/LX/LXT 2T • Vespa ET4 125 (96/99) • 250 Hexagon GT/GTX  
**Suzuki** CP 50 • Address 50/100 • AP 50 • AJ 50 • Katana 50/IE (97/06) • Estilite 50 • Zillion 50  
**Yamaha/MBK** CR-Z 50 • Target 50 • CT 50 S/SS • Sorriso 50 • New Sorriso 50 • Jog Z 50 (95/96) Booster 100 • BW'S 100

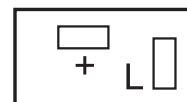
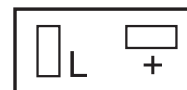

Rif. Aprilia: AP8124235

Rif. Gilera: 322520 • 291016/2

Rif. Cagiva: 37513

Rif. Honda: 38301-GE8-008 (Denso) • 38301-GJ0-713 (Mitsuba) • 38301-KK4-024 • 38301-GK8-014

Rif. Denso: FZ222SD • FZ225SD • FZ218SD

Rif. Mitsuba: FR-2201/2202

Rif. Malaguti: 02502300

Rif. Piaggio: 291016/2

Rif. Suzuki: 38610-09410/36C00 • 38610-02E00

Rif. Yamaha/MBK: 1MH-H3350-V0

- 02.77651** intermittenza elettronica "Guilera" 12V - 21Wx2+3,4W - c.c. - 2 faston medi - c/supporto

Adattabile su:

**Honda** CA 125 Rebel (95/99) • CBR 125 R (04/10) • CB 125 S (84/85) • VT 125 Shadow (99/06) CB 125 TD/TT (88/90) • CH 125 • NX 250 (88/93) • XLR 125 R (98) • CM 125 C (85/99) • MTX 125/200 (84/87) CB 250 Two Fifty (91/04) • CMX 250 C (96/03) • XL 200 R/PD • CN 250 • XL 350 R • XL 600 R/PD XL 600 RM/LM • XL 600 V Transalp (87/93) • XRV 650 Africa Twin • NX 650 Dominator (88/92) XRV 750 Africa Twin (90/92)  
**Kawasaki** ZZR 250 (96/03) • ZXR 400 (90/98) • EN 500 (92/95) • GPZ 500 S (87/00) • KLE 500 (91/99) GPZ 550 (84/85) • GPX 600 R (88/90) • GPZ 600 R (87/88) • KLR 600 (91/94) • ZZR 600 (90/92) KL 650/Tengai (87/91) • KLX 650 (93/95) • ZR 750 Zephyr (91/94) • ZX-9R 900 (94/97) • GTR 1000 (96/97) 1000 ZX10 (88/90) • ZZR 1100 (90/92)  
**Suzuki** RG 500 Gamma • GSX 550 ESD/ESF • DR 600 R/SF (85/89) • GSX 1100 R (86/92) • GSX F1100 (88/93) DR 650 R/RS/RSE (90/93) • DR 750/800 • GSX-R 750 (85/95) • Intruder 750 (85/91) • GSX-F 750 (86/96) VX 800 (90/94) • Intruder 1400 (87/95) • AN 125/150 • GS 500 E (89/96) • GSF 400 Bandit • DR 350 S/SE (90/98) RG/RGV 250 • TS 125 • RG 125 • GN 125 • TR 50  
**Yamaha** XT 350/400/550 • XT 600 Ténéré • XT 600 (4 valvole) • SRX 600 • TW 200 XT 600 Ténéré c/avviamento • XTZ 750 • RD 350/500 • TDR 125 • DT 125 R (89/92) • XC 125 Beluga

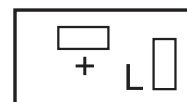

Rif. Denso: FZ249SD

Rif. Honda: 38301-MG2-008 • 38301-KJ6-743 • 38301-KGO-024

Rif. Kawasaki: 27002-1053

Rif. Mitsuba: FR22-04

Rif. Suzuki: 38610-31310/31X50

Rif. Yamaha: 34L-83350-20

Sostituisce: Mitsuba 02.7765

**02.7705** intermittenza elettronica a circuito integrato "Denso" 12V - 85 C/M (21/23/27)W x 2 - c.c. - 2 minifastonDi primo equipaggiamento su:

**Honda** 125/150 @/Dylan (00/03) • 125/150 SH (01/03)  
 125/150 Dylan (02/06) • 125/150 Pantheon 4T (03/06)  
 VTR 250 (09) • CBR 600 F/FS/FR (01/04)  
 CBR 600 RR (03/06) • CBR 1000 RR (04/05)  
 VFR 800 VTEC (02/09) • VTR 1000 SP (03/06)  
 XL V Transalp 650 • NT V Deauville 650  
 CB Hornet 900 • XLV Varadero 1000 (03/06)  
 VTR 1000 SP (03/06) • ST 1300 Paneuropean (02/09)  
 VTX 1300 • VT 1300 CX • CB 1300 • VTX 1800  
**Kawasaki** BN 125 (00/07) • EL 250 (01/03)  
 ZXR 400 (99) • EN 500 (96/03)  
 500 ER5 (97/05) • GPZ 500 S (98/03)  
 GPZ 500 S (98/03) • ZX-6R 600 (98/01)  
 ZX-6RR 600 (03/04) • ZX-6R 636 (02/04)  
 ZZR 600 (99/06) • W 650 (99/05) • KLR 650 (95/04)  
 ZX-7R (96/02) • ZR7/S (99/03) • Z 750 (04/06)  
 VN 800 Classic (96/06) • W 800 (11) • ZX-9R 900 (98/03)  
 VN 900 Classic/Custom (06/11) • Z 1000 (03/06)  
 ZX-12R 1200 (00/06) • 1200 ZRX/R/S (01/06)  
 ZZR 1200 (02/03) • ZZR 1400 (06/11)

Rif. Honda: 38301-MBW-D21

Rif. Kawasaki: 27002-1101/1063/1092

**Yamaha** DT 125 R (99/00) • SR 125 (99/00)

TW 125 (99/03) • XV 125 Virago (97/00)  
 XVS 125 Dragstar (00/04) • XV 250 Virago (95/99)  
 XVS 250 Dragstar (01/04) • Majesty 250 (96/06)  
 Majesty 400 (04/11) • T-Max 500 (01/11)  
 FZR 600 R (94/95) • XJ 600 S Diversion (96/02)  
 XT 600 E (95/02) • YZF 600 R Thundercat (96/02)  
 YZF 600 R6 (99/02) • XTZ 660 (93/96)  
 YZF 750 R/SP (93/96) • YZF 750 R7 OW02  
 TDM 850 (96/01) • TRX 850 • FZR 1000 (94/95)  
 FZS 1000 (01/05) • YZF 1000 R Thunderace  
 YZF 1000 R1 (99/01) • XV 1100 Virago (96/97)  
 XVS 1100 Dragstar (99/02)  
 XVS 1100 A Dragstar Classic (00/06) • XJR 1200  
 FJR 1300 • XJR 1300 • XVZ 1300 TF Royalstar Venture (00)  
 XVZ 1300 Royalstar (96/00) • XV 1600 Wildstar (99/02)

Rif. Denso: FE246BH (066500-4020)

Rif. Yamaha: 3GM-83350-01 • 4MY-83350-01

**02.7710** intermittenza elettronica 12V 2x10W+3,4W (4x10W) - c/dispositivo 4 frecceAdattabile su:

**Cagiva** City 50 (91/94) • 50 W4 (92/95) • Prima 50 3V/6V (92/94) • 50 Cucciolo (98/99) • Supercity 125 (97/99)  
 Planet 125 (98/03) • Raptor 125/EU2/EU3 (04/07) • 125 W8/FA (93/98) • 125 Mito/EV/EU2/EU3 (94/07)  
 350 W12 (93/95) • 500 W16 (94/99) • 650 Raptor/V/IE (01/06) • Elefant 750 (93/95) • Elefant 900 (93/97)  
 Navigator 1000 (00/05) • Raptor 1000/V/Xtra (00/05)  
**Husqvarna** 125 WRE-SM/SMS (98/05) • TE 410 E (99/00) • TE 610 E/LT/Dual Purpose (98/04) • SM 610 S (98/04)  
**MV Agusta** F4 750 (99/03) • F4 1000/R/Veltro (04/08) • F4 1078 100 cc (07)  
 Rif. MV Agusta: 800088173 • 800070228

Di primo equipaggiamento su:**MV Agusta** F4 1000 312 R (07/08) • F4 1078 312 RR (07/08)

Rif. MV Agusta: 8000B1352

**02.7715** intermittenza elettronica LED 12V 2X (4x2,3W) - c.c. - 3 faston c/dispositivo 4 frecceDi primo equipaggiamento su:

**Aprilia** RS 50 (06/10) • RS 125 (06/10)  
 Scarabeo 125/200 IE Light (09/10)  
 RX 125 (08/10) • SX 125 (08/10)

Adattabile su:

moto c/indicatori direzionali a LED

Rif. orig.: AP8127847

**02.7722** intermittenza elettronica monocanale 12V - 10W+10W - c.a. 3 faston medi (funzionamento simultaneo ant. e post.)Di primo equipaggiamento su:

**Rieju** MRX 50/Pro (02/05) • RR 50 (03/>)/Sport (05)  
 SMX 50 (05) • Spike 50 (02/05)  
 Spike 50 Sport (03/05)

Adattabile su:

ciclomotori e moto enduro

c/impianto 12V - s/batteria

Rif. Rieju: 00012005031

**02.7720** intermittenza elettronica 12V - 10Wx2 - c.c. 2 faston medi - c/staffaDi primo equipaggiamento su:

**Betamotor** 50 Ark/LC/LC K (96/10)  
 50 Quadra Chrono 502 (95/99)  
 50 Tempo (96/99) • 50 Supermotard (98/99)  
 50/125/150 Eikon  
 Rif. orig.: 188494000

**02.7725** intermittenza elettronica 12V - 10Wx2+1,2W c.c. - connettore 2 spinottiDi primo equipaggiamento su:

**MBK** Ovetto 50 (01/03)/100  
**Yamaha** Neo's 50 (01/06)/100  
 Rif. orig.: 5KK-H3550-00/01 (1P9-H3350-00)



**02.7727** intermittenza elettronica 12V - 20W (10x2) - c.c.  
3 faston medi



Di primo equipaggiamento su:

**Ducati** Indiana 350/650/750  
Monster 400 (95/03)/600 (93/01)/750 (96/01)/  
900/IE (93/01)  
Supersport 400 (93/97)/600 (91/97)/750/IE (91/00)  
Supersport/Superlight 900/IE (91/00)  
851 Superbike Biposto (91/92) • 888 Superbike Strada/SP5 (93/95)  
748 Biposto (98/01) • 748 SPS (98/99) • 748 Testastretta (01)  
748/R/S (00/02) • 916 SP (94/96) • 916 Biposto/Senna (94/98)  
916 SPS (97/98) • 996/SPS/SPS II/SPS III (99/00)  
996/S (01) • 944 ST2 (97/03) • 916 ST4 (99/03)  
Rif. orig.: 53840051A (036138350)

**02.7730** intermittenza elettronica 12V - 2x10W - c.c.  
2 faston c/connettore



Adattabile su:

**MBK** Booster 50 Spirit/Euro 2 (99/02)  
Nitro 50 (97/02) • Booster 50 (01/02)  
Booster 50 L (01/03) • Booster 50 NG/Euro 1 (95/03)  
Stunt 50 • Nitro 100  
**Yamaha** BW'S 50 Next Generation/Cat. (97/06)  
BW'S 50 Original/Euro 2 (99/02) • BW'S 50 R (01)  
Slider 50 • Aerox 50/R (97/02) • Aerox 100  
BW'S 50 Bump (97/98) • BW'S 50 Spy (95/98)  
Rif. orig.: 5BR-H3350-02 • 4TD-H3350-01

**02.7732** intermittenza elettronica a circuito integrato 12V - (21W+10W+1,2W)x2 - c.c. - 8 pin  
c/dispositivo 4 frecce (SMART WARNING CONTROL UNIT)



Di primo equipaggiamento su:

**MBK** Skyliner 125/180 (03/>) • Kilibre 300  
**Yamaha** Majesty 125/180/E (03/>) • Versity 300/XC  
Rif. orig.: 5SE-H3350-00/01/02

**02.7750** intermittenza elettronica 12V - 10-21W - c.a. - basculante - 3 faston medi (funzionamento alternato ant. e post.)

Di primo equipaggiamento su:

**Piaggio** Ape P 50 (TL3 - 80/85 - s/avv.to) • Ape TMP 50 (85/89) • Boss 50 (c/frecce) • Grillo 50 (c/frecce)  
Si 50 Mix/FL2 (91/99 - c/frecce) • Vespa PK 50 S/SS/125 S (s/avv.to) • Vespa PK 50 S/125 S Automatica (s/avv.to)  
Vespa PK 50 XL • Vespa PK 50 XL Rush (s/avv.to) • Vespa PK 50 N • Vespa PK 50 FL • Vespa PK 125 XL/FL  
Cosa 125/150/200/CL/CLX/Cosa 2 • Vespa PX-E Arcobaleno 125/150/200 (s/avv.to) • Vespa PX 125 T5  
Vespa 125 ETS (s/avv.to) • Vespa PX 125 Euro 2 (01/06) • Vespa PX 125/150/200 (98/01) • Vespa PX 125/150 (11)  
Vespa PX 125/150 (s/batteria) • Vespa P 200 E (s/batteria) • Vespa PX 125 30 Anni (07/08)  
**Malaguti** MDX 50/Gold • MGX NL • MLX 50 • MEX 50 • Enduro 50 Dune • Fifty 50 CX/HF/Top (89) • MRX 50  
Rif. Piaggio: 197283 • 1957035 (195703) • 163968 • 213594  
Rif. Malaguti: 02500300



**02.7755** intermittenza elettronica monocanale - 6V - 21W - c.a.  
2 faston medi (funzionamento simultaneo ant. e post.)



Di primo equipaggiamento su:

**Piaggio** Ape 50 TL1/TL2 (</80)  
Vespa PX/PE (estero) • Vespa 50 Elestart (estero)  
Vespa 90/SS/100 (estero)  
Vespa 50 S (estero) • Vespa 125 Primavera/ET3 (estero)  
Rif. orig.: 187990 ex 154578

**02.7758** intermittenza elettronica 12V - 20W - c.c. - 4 faston medi



Di primo equipaggiamento su:

**Piaggio** Ape P50 (84/> - c/avv.to)  
Vespa PK 50 S/SS (c/avv.to)  
Vespa PK 50 XL Rush (c/avv.to)  
Vespa PK 50 FL2 Automatica  
Vespa PK 50 N Speedmatic  
Vespa PK 50 XL Plurimatic (c/avv.to)  
Vespa PK 50/125 S Automatica (c/avv.to)  
Vespa PK 125 S (c/avv.to) • Vespa P125 ETS (c/avv.to)  
Rif. orig.: 199490 (217351/199930)

**02.77621** intermittenza elettronica 12V - 10+21+1,2W - c.c. - 2 faston medi  
c/supporto



Di primo equipaggiamento su:

**Yamaha/MBK** Majesty/Skyliner 125/150 (98/02)  
Doodo/Teo's 125/150  
Rif. orig.: 5DS-H3350-00 • 5HT-H3350-01 • 5MF-H3350-00

**02.7766** intermittenza elettronica 12V - 10Wx2+3,4W - c.c. - 3 faston medi  
c/supporto



Adattabile su:

**Piaggio** Ape 50 FL3/Europa (96/99)  
Rif. orig.: 294141  
Rif. Denso: FA221ED (066500-1560)

**02.7768** intermittenza elettronica 12V - 20W (2x10) - c.c. - 4 faston medi  
c/gommino di supporto

Adattabile su "Transval":

**Peugeot** Zenith 50

50 Buxy • Speedake 50 • Fox 50

**MBK** Booster 50 (90/94) • Evolis 50

50 Booster Spirit/Road (96/98)

**Gilera** GSA 50 (c/avv.to) • RV/RX 125/200 (c/avv.to)

RTX 125/200 • Arizona Hawk 125/200

RRT 125 Nebraska/Fast Bike • 125/200 Arizona Rally (c/avv.to)

Rif. Peugeot: 708607

Rif. MBK/Yamaha: 3VL-H3350-00

Rif. Gilera: 318391



**02.7775** intermittenza elettronica c/segnalatore acustico - 12V  
10Wx2+3,4W - c.c. - 3 faston mini

Di primo equipaggiamento su:

**Kymco** People 125/150/Euro 2 • Agility 125/Euro 3

Vivio 125/150 • Grandink 125/150/Euro 2

Movie 125/XL/Euro 2/3 • MXU 150 • MXER 125/150

People 250 • Gran Dink 250/Euro 2 • Yup 250 • 250 MXU

250 KXR • Maxxer 300 • MXU 300 • Agility 50 4T • Filly 50/LX

Heroism 50 • Maxxer 50 • MXU 50/SR • KXR 50

MXER 50 /Euro 2 • Peolple 50/Euro 2 • Vitality 50 2T/4T • Yup 50

Rif. orig.: 00151708 • 38300-KECE-900



**02.7778** intermittenza elettronica a circuito integrato "Mitsuba" 12V - 21/23Wx2+3,4W - c.c. - 3 faston mini (Mitsuba FR-3303)

Di primo equipaggiamento su:

**Honda** 50 Zoomer (05/06) • @ 125/150 (04/06) • SH 125/150/IE (04/10)

PS 125/150 i (06/07) • XL 125 V Varadero (07/11) • Jazz 250 (04)

Foresight 250 (05/>) • Forza 250 X/EX (05/10) • SH 300 (07/10)

Silver Wing 400 • SW 400 T • VT 750 S/CS (10/11) • VT 750 C2/C2S

Shadow Spirit (07/11) • CBF 500/ABS (04/06) • CB 600 F Hornet (05/06)

CBR 600 F (05/06) • CBF 600 N/NA/S/SA (04/06) • FMX 650 (05/06)

VT 750 C/CA Shadow (04/11) • CB 1100 X11 (00/01)

GL 1800 (06/12) • FES 250 Foresight (98/99) • NSS 250 Jazz/A (01/03)

TRX250X (10) • CB 350/450 S • VFR 400 R (90/91) • XBR 500

CB 600 F Hornet (98/04) • CB 600 S Hornet (00/02)

CBR 600 F (87/00) • VT 600 C Shadow (98/99) • FX 650 Vigor (99/00)

SLR 650 (97/98) • VF 750 C Shadow (88/99)

VT 750 C/C2/C3 Shadow (01) • NV 750 C • NR 750 (92)

VFR 750 F (89/97) • VFR 750 R RC 30 (88/90) • RVF 750 R RC45 (94/95)

PC 800 Pacific Coast (89/90) • VFR 800 FI (98/01)

CBR 900 RR Fireblade (92/01) • CB 1000 F Big One (93/96)

CBR 1000 F Hurricane/Dual CBS (87/98) • XL 1000 V Varadero (99/02)

VTR 1000 F Fire Storm (97/06) • VTR 1000 SP (01/02)

ST 1100 Pan European ABS (93/02) • ST 1100 Pan European (90/00)

CBR 1100 XX Super Blackbird (97/06)

GL 1500 F6C Valkyrie (97/03) • GL 1500 CT Valkyrie Tourer (97/00)

Rif. Honda: 38301-MEG-000 • 38301-MR7-004 • 38301-KK9-952



**02.7779** intermittenza elettronica "Mitsuba" 12V - 10Wx2+1,7W - c.c. - 2 faston (Mitsuba FR-2229)

Di primo equipaggiamento su:

**Gilera** Runner 50 Purejet Race (06/11)

**Piaggio** 50 NRG Power Purejet (06/11) • Beverly 125 4T-4V IE (10/11) • Vespa GTS 125 Super (09/11)

Vespa LX 150 Touring (10/11) • 250 Beverly Sport (06/08) • Beverly 250 Tourer (08/09)

Beverly 250 IE Euro 3 (06/08) • Vespa GTV 250 (06/09) • Carnaby 250 (08/10) • Vespa 250 GTV Navy (08)

Beverly 300 RST IE (10/11) • Beverly Tourer 300 (09/10) • Carnaby 300 Cruiser (09/10)

X7 300 Evo ie (09/10) • Vespa 300 GTS Super/Supersport (08/11) • Vespa 300 GTV (10/11) • Beverly 400 Tourer (08/10)

XT 750 • X8 250 (05/06) • 250 Vespa GT 60 Euro 3 (06/07) • Vespa GTS 300 IE Touring (11)

Rif. orig.: 638755 • 640289



**02.7770** intermittenza elettronica c/segnalatore acustico  
12V - 10+10+3W - c.c. - 3 faston mini

Adattabile su:

**Honda** SP 50 Dio • Bali 50/100

**Kymco** 50 DJX/DJY/DJW • 50 KB/K 12

Bet&Win 50/125/150/250/Euro 2

Fever 50 ZX/Euro 2 • 50 CX/Super • Heroism 125/150

**Piaggio** Ape 50 Cross • 125/150 Skipper 2T

Rif. Honda: 38301-GS7-015/035

Rif. Kymco: 38301-GS7-005 • 00151016

Rif. Piaggio: 292114 (Omron G8MH)



**02.7776** intermittenza elettronica 12V - 10Wx2+3,4W  
c.c. - 2 faston medi

Di primo equipaggiamento su:

**Sym** DD 50/Euro 2 • Mask 50/Euro 2 • Attila 125/150

Euro MX 125/150/Euro 2 • Joyride 125/150/200/Euro 2

Megalò 125 • Shark 125/150 • Superduke 150

HD 125/200/Evo/Euro 2/3/I • New Duke 125

Rif. Sym: 38301-A31-000 (Omron G8MF • Denso FV223S)



**02.7740** dispositivo c/interrittenza elettronica a circuito integrato 12V - 21Wx2 (H21Wx4) - c.c. - 4 frecce - c/relé comando pompa carburante - 7 pin

Adattabile su:

**Suzuki** 125 RV Van Van (03/10) • 125 VL Intruder (00/07) • 125 VZ Marauder (98/04) • 250 TU-X (97/01)  
250 VL Intruder (00/07) • 250 VZ Marauder (99/07) • 250 AN Burgman (98/06) • 400 AN Burgman (99/11)  
400 DR-Z/E/S/SM (00/09) • 600 GSF Bandit (00/04) • 600 GSX-F (98/06) • 600 GSX-R (97/11)  
650 AN Burgman/Executive (03/09) • 650 DL V-Strom (04/11) • 650 SV (99/10) • 650 GSF Bandit (05/08)  
650 GSX-F (08/10) • 750 GSX-F (98/06) • 750 GSX-R (96/11) • GSR 750 (11) • 750 GSX (98/01)  
800 VZ Marauder (97/02) • 800 VL/VZ Intruder/C800/M800 (97/11) • VL 800 Volusia (01/05) • 1000 DL V-Strom (02/10)  
1000 SV (03/07) • 1000 GSX-R (01/11) • 1000 TL R (98/00) • 1200 GSF (01/06) • 1200 GSX (99/02) • GSF 1250 Bandit (07/10)  
GSX 1250 F (10) • 1300 GSX B-King (08/09) • 1300 GSX-R Hayabusa (99/11) • 1400 GSX (02/07) • 1500 VL Intruder (98/08)  
1800 VLR (08/11) • 1800 VZR (06/09)

Rif. Denso: FE249JR (066500-4230)

Rif. Suzuki: 38610-03F00 • 38610-10G00



## Interruttori stop

**02.58077** interruttore stop c/molla per pedale freno - contatto aperto - funzionamento a tirare



Adattabili su:

**Innocenti** Lambretta

**Moto varie**

**Moto d'epoca**

**02.7774** interruttore stop al pedale - bottone rosso  
contatto chiuso - in plastica nera - s/guarnizione - bottone nero

**02.77747** interruttore stop al pedale - contatto chiuso  
in plastica grigia - c/guarnizione nera - adattabile



Di primo equipaggiamento su:

**Piaggio** Vespa PK 50 S/SS XL/XL Rush/N/FL/FL2  
Vespa PK 125 S/XL/FL • Vespa P 125 ETS • Vespa P 125 T5  
Vespa P 125/150 X (c/frecce) • Vespa P 200 E (c/frecce)  
Vespa PX 125/150/200 E Arcobaleno (c/frecce)  
Vespa PX 125/150/200 (98/11)

Rif. orig.: 181881 (073611)

**02.77777** interruttore in plastica nera - c/guarnizione nera - adattabile



Interruttore stop freno post. (pedale) adattabile su:

**Piaggio** Vespa 125 (VNB1 - 59/61 - c/batteria)  
Vespa 125 TS (c/batteria) • Vespa 150 (VBA/VBB - 58/67)  
Vespa 150 GL (c/batteria) • Vespa 150 Sprint/Sprint Veloce (c/batteria)  
Vespa 150 GS (VS4/VS5 - 59/61) • Vespa 180 SS (65/68 - c/batteria)  
Vespa 125/150 Super (c/batteria) • Vespa 125 GT/GTR (c/batteria)  
Vespa 180/200 Rally (c/batteria) • Vespa 150 USA (VB1 - 57/58)  
Vespa GS 160 (c/batteria) • Vespa 180 SS (c/batteria)  
Vespa 180/200 Rally (c/batteria)

Interruttore luce pianale adattabile su:

**Piaggio** Ape Car P2/P3 (pianale) • Ape MP P501/P601 (pianale)  
Ape Car Diesel/Max Diesel (pianale) • Ape Poker Benz./Diesel (pianale)

Rif. orig.: 093722 • 086322 • 181637 • 082775

**02.7769** interruttore stop al pedale - bottone nero  
contatto aperto - in plastica nera - s/guarnizione



Di primo equipaggiamento su:

**Piaggio** Vespa 50 Special (65/83) • Vespa 50 S/SS Super Sprint/Sprinter  
Vespa 90/SS/Racer • Vespa 125/Primavera/ET3  
Vespa PK 125 (s/frecce - 82/84) • Vespa P 125/150 X (s/frecce)  
Vespa P 200 E (s/frecce) • Vespa PX-E 125/150/200 (s/frecce)

Rif. orig.: 181878 (070138)

**02.7799** interruttore stop al pedale - in plastica grigia - c/guarnizione nera

**02.77997** interruttore stop al pedale - in plastica nera - c/guarnizione nera  
adattabile



Adattabile su:

**Piaggio** Vespa 125 (VNB2/VNB6 - 61/66 - s/batteria)  
Vespa 125 TS • Vespa 125 GT/GTR (s/batteria)  
Vespa 180 SS (s/batteria) • Vespa 150 Sprint  
Vespa 125/150 Super (s/batteria) • Vespa 180/200 Rally (s/batteria)  
Vespa 150 Sprint Veloce (s/batteria) • Vespa 160 GS (s/batteria)

Rif. orig.: 055316

**02.78003** interruttore stop dx/sx alla leva - contatto chiuso - in metallo



Adattabile su:

**Benelli** 50 491 • K2 50/100 • 50 Naked • Pepe 50  
Adiva 125/150 • Velvet 125/150/250/400  
**Beta** Ark 50/LC/K • Eikon 50/125/150 • Tempo 50 • Quadra 50  
Alp 125/200 4T (00/05) • REV 3 125 (03) • RR 125 4T (05/06)  
Techno 125/250 • REV 3 250/270 (00/04) • Euro 350 • Jonathan 350  
**Italjet** Dragster 50/125/150 • Formula 50/125  
Torpedo 50/125/150 • Millenium 125/150  
**Peugeot** Fox 50 • Speedfight 50/100 • ST Rapido 50  
SV 50/100/125 Geo • Elyseo 50/100/125/150 • Vivacity 50/100  
X-Fight 50/100

**Scooter vari**

Rif. Benelli: R51840061A0

Rif. Beta: 1887000000

Rif. Italjet: 3372227

Rif. Peugeot: 063357



**02.78009** interruttore stop dx - alla levaAdattabile su:

**Honda** SFX 50 • Sky 50 • SH 50/100  
 SRX 50/90 Shadow • 50 X8RS/X8RX • CA 125 Rebel • S-Wing 125/150  
 CB 125 Twin • NSR 125 F • SH 125/150/IE • Dylan 125/150  
 Pantheon 125/150 2T/4T • NX 125/250 • CB 250 Two Fifty  
 CMX 250 Rebel/450 • Jazz 250/ABS • CN 250 Helix/Spazio  
 XR 250/400/600/650 • XRV 650 Africa Twin • VT 600 C Shadow (88/92)  
 NX 650 Dominator (88) • XLV 600 Transalp (87/93)  
 VT 1100 C Shadow (88/92)  
*Rif. orig.:* 35340-MA5-671

**02.78011** interruttore stop dx - alla levaAdattabile su:

**Suzuki** AP 50 • AH 50/100 Address • AJ/ZZ 50 Sepia  
 Katana 50/LC • Street Magic 50 • Zillion 50 • Estilete 50  
 UG 110 Hokuto • RG 125 • GN 125 • DR 125/SE • TS 125 R  
 Marauder 125 • Intruder 125 (</04) • RV 125 Van Van • AN 125/150  
 UE 125/150 • Epicuro 125/150 • Burgman 125/150 (02/06)  
 Burgman 250 (98/02) • GRV 250 • GN 250 • TU 250 X • Marauder 250  
 Intruder 250 (</04) • DR 350 S/SE (90/98) • SRZ 400 S • Bandit 400  
 Burgman 400 (99/02) • GS 500 E • GS 500 (01/07) • Intruder 600  
 Bandit 600 • RF 600 • GSX 600 F • GSX 600 R (97/03) • Burgman 650 (03)  
 LS 650 Savage • DR 650 R/RE/SE/RSE/RS (90/97) • XF 650 Freewind  
 SV 650 (</03) • GSX 750 F • GSX 750 R (88/03) • GSX 750  
 Intruder 750/800 • DR 750/800 Big • Marauder 800 • RF 900 • SV 1000 (</03)  
 TL 1000 S/R • GSX 1000 R (01/04) • V Strom 1000 • GSX 1100 R/F  
 Bandit 1200 • GSX 1200 • GSX 1300 R • GSX 1400 • Intruder 1400/1500  
*Rif. orig.:* 57460-17C00/01

**02.78013** interruttore stop dx - alla levaDi primo equipaggiamento su:

**Kymco** Agility 50 4T/R10/R12/R16 • Agility 50 R16 2T • Agility 50 RS Naked 2T • B&W 50/Euro 2  
 CX 50/Super • Dink 50/Classic/Euro 2 • Dink 50 4T • Fever 50 ZX/Euro 2 • People S 50 2T/4T • Heroism 50  
 Like 50 2T/4T • KB 50 • K12 50 • Sniper 50/DD • Super 9 50/Sport/Euro 2 • Top Boy 50 • Yup 50 • Agility 125  
 Agility R16 125/150/200 • Downtown 125/200/300 • Like 125/200 • B&W 125/150/250/Euro 2 • People GTi 125/200/300  
 Super 8 50/125 • Dink 125/150/200/LX/Classic/Euro 2/Euro 3 • Gran Dink 125/150/250/Euro 2 • Heroism 125/150  
 Movie 125/150/XL/Euro 3 • People S 125/200/250/300 • People 250 • Vivio 125/150 • Zing 125/150 • Venox 250/Euro 2/Euro 3  
 X-Citing 250/IE/300 IE/500/IE • Yup 250  
*Rif. orig.:* 35340-KNBN-901 • 00154204

**02.78014** interruttore stop sx - alla levaDi primo equipaggiamento su:

**Kymco** Agility R16 125/150/200 • Mixer 50/Euro 2  
 MXU 50/SR • Sniper 50 DD • Super 9 50 Sport Euro 2  
 B&W 125/150/250/Euro 2 • Like 125/200  
 Dink 125/150/200/LX/Classic/Euro 2/Euro 3  
 Downtown 125/200/300 • Gran Dink 125/150/250/Euro 2  
 People S DD 125/200 IE • People GTi 125/200/300  
 People 250/S/300 S • KXR 250 • MXU 250/300/500 • Maxxer 300  
 X-Citing 250/IE/300 IE/500/IE • Yup 250  
*Rif. orig.:* 35350-KNBN-901 • 00155604

**02.78019** interruttore stop dx/sx - alla leva - in plastica nera - pulsante rossoAdattabile su:

**Aprilia** Sportcity One 50 2T/50 4T/125 (08/10) • SR Max 125/300 (11)  
**Derbi** Boulevard 50/125 (08/09) • Sonar 50 2T • Sonar 125/150  
**Gilera** Runner 50 SP (05/10) • Runner 50 Purejet (05/10) • Runner 125//800 VX/VXR (05/10) • Nexus 500 (03/08)  
 Fuoco 500 (07/09) • Nexus 125/250/300 (06/08)  
**Piaggio** 50 Fly 2T/4T • Liberty 50/Sport 2T/4T (04/>) • Vespa 50 LX/S 2T/4T • 100 Fly • Beverly 125/Sport/Tourer (04/>)  
 125 Carnaby-Vespa GTS-MP3 • 125 X9 Evolution (03/>) • 125/150 Fly-X8/Premium/Street • 125/150 Vespa LX/S/IE  
 200 X8-X9-Vespa GTS-Liberty • 250 Beverly/Sport/Tourer • 250 Carnaby-X8-X9-MP3-Vespa GTS • 300 Beverly Tourer-MP3-Vespa GTS  
 400 Beverly/Tourer-MP3-X8 • 500 Beverly • 500 X9 (03/07)  
*Rif. orig.:* 583575 (584480)

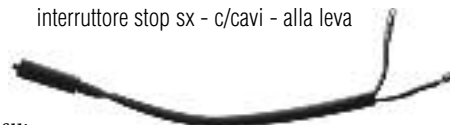
**02.78010** interruttore stop sx - c/cavi - alla levaAdattabile su:

**Honda** SH 50 • SH 100 • SFX 50 • SRX 50 • SA 50 Vision  
**Kymco** 50 Agility R10/R12/R16 • 50 Agility 2T RS/R16  
 50 CX/Super • 50 DJ • 50 Fever ZX/Euro 2 • 50 KB • 50 K12  
 50 Filly/LX • 50/100 Top Boy • 50 People/Euro 2 (99/11)  
 50 People S 2T/4T • 50 Super 8 2T/4T • 50 Yup/Euro 2  
 50 Vitality 2T/4T • 50 Like 2T/4T • 50 Sento • Agility 125 R12/RS  
 People 125/150/Euro 2/Euro 3 (99/11) • People S 125/200 (05)  
 Super 8 125 • Movie XL 125/150/Euro 2/Euro 3 • Vivio 125/150  
*Rif. Honda:* 35340-GS7-003  
*Rif. Kymco:* 00152009 • 00152053  
 (35340-GN2-770 • 35340-GBN2-770 • 35340-KFLF-900)

**02.78012** interruttore stop c/adattatore dx/sx s/cavi - alla levaAdattabile su:

**Malaguti** Centro 50/SL • Crosser 50  
 Ciak 50/TD/100/125/150/200/Master/Euro 2/3 (99/06)  
 Yesterday 50 • F10 Jetline (92/06)  
 F12 Phantom 50/F12R (94/10)  
 F15 Firefox 50 (96/06) • F12 100  
*Rif. orig.:* 01714000

**Sostituisce:** 02.78006/78007/78016/78017

**02.78020** interruttore stop dx/sx - alla leva - contatto chiuso - in metallo - pulsante verde

Di primo equipaggiamento su:

**Aprilia** Scarabeo 50 4T-4V Net • Scarabeo 100 4T Net (10) • Atlantic 125/300 (11)  
Sportcity Cube 125/250 (08/10) • Leonardo 250 (02/04) • 750 Shiver (10)

**Gilera** DNA 50 (00/04) • Eaglet 50 • GSM 50 • Ice 50 • RK 50 • Runner 50/SP (97/02) • Runner 50 Purejet (02/04)

Stalker 50 • Typhoon 50/125/X/XR • Zulu 50 • Runner 125/180/FX/FXR/SP 2T • Runner 125/180/200 VX/VXR 4T (00/04) • R 600 • RC 600/Cobra

**Piaggio** Ape 50 FL3/Europa/RST Mix (99/05) • Ciao Mix/Euro 1/2 (96/04) • Free 50/FL/Delivery • Liberty 50 2T (97/05)

Liberty 50 PPTT Euro 2 (04/05) • Liberty 50 4T (00/02) • NRG 50/MC<sup>2</sup>/Extreme/MC<sup>3</sup> • NTT 50 • Sfera 50/RST • Si 50 Mix (96/99)

Typhoon 50 (01/06) • Vespa 50 ET2/IE/ET4 • Zip 50 4T (00/06) • Zip 50 Base/RST/Fast River/RST • Zip 50 SP • Free 100 • Beverly 125/200 (01/03)

Hexagon 125/150/180/LX/LX4/LXT/GTX/Super Hexagon • Liberty 125/150 (98/02) • Skipper 125/150/LX/4T • Sfera 125

Vespa ET4 125/150 • Vespa PX (98/06) • X9 125 (01/02) • X9 125 • X9 180 • X9 250 (00/01) • Hexagon 250 GT/GTX • X9 500 (01/02)

Rif. orig.: 580953 (580723/294619/246419)



Sostituisce 02.78008 • 02.780081

**02.78021** interruttore stop dx/sx - alla leva  
in plastica - c/cavi



Adattabile su:

**Yamaha** SR 125 • TW 125 • 125 DT R/X (05/06) • DT 125 RE (99/00)  
125/250 Virago/Dragstar • Majesty 250 • XTZ 660 Ténéré (94/96)

**MBK** Skyliner 250

Rif. orig.: 2UJ-83980-00

**02.78022** interruttore stop dx/sx - alla leva - in metallo  
pulsante nero - c/cavi



Adattabile su:

**Yamaha** Axis 50 • Aerox 50 (97/00)

Breeze 50 • BW'S 50 Next Generation (97/99)

BW'S 50 Original (97/00)

BW'S 50 Bump (97/98) • BW'S 50 Spy (97/98)

Neo's 50 2T (97/10) • Neo's 100 • Neo's 50 4T

Why 50 (98/00) • Majesty 125/150/180

**MBK** Booster 50 NG (97/99) • Booster 50 Spirit (97/00)

Booster 50 Road (94/95) • Booster 50 Track (97/98) • Evolis 50 • Fizz 50

Forte 50 • Flipper 50 (98/00) • Nitro 50 (97/00) • Ovetto 50 2T (97/10)

Ovetto 100 • Skyliner 125/150/180

Rif. orig.: 5XL-H3980-00

**02.78023** interruttore stop dx/sx - alla leva - in plastica grigia  
pulsante bianco - c/cavi



Adattabile su:

**Yamaha** Aerox 50 (01/09) • Aerox 100

BW'S 50 Next Generation (00/06)

BW'S 50 Original (01/03) • BW'S 50 R (01)

BW'S 50 L (03/04) • BW'S 50 (04/10)

Why 50 (01/06) • Teo's 125/150 • Maxster 125/150

**MBK** Nitro 50 (01/09) • Nitro 100 • Booster 50 NG (00/06)

Booster 50 Spirit (01/03) • Booster 50 L/R (01/04) • Flipper 50 (01/06)

Doodo 125/150 • Thunder 125/150

Rif. orig.: 5JH-H3980-02

**02.78024** interruttore stop dx - alla leva



Adattabile su:

**Yamaha** TT 600 R/RE • YZF 600 R • XJ6 600

FZS 600/Fazer • FZ6 600/N/S/Fazer • YZF 600 R6 • 660 MT-03

XTZ 660 (08/10) • YZF 750 R/SP • YZF 750 R7 • TRX 850

TDM 900 • YZF 1000 R1 • YZF 1000 R • FZS 1000/Fazer

FZ1 1000/Fazer • BT 1100 • XJR 1200/1300 • FJR 1300

XVS 1300 (96/00) • 1700 MT-01 • XV 1600/1700/1900

Rif. orig.: 4HM-83980-00

**02.78025** interruttore stop dx - alla leva - in plastica



Adattabile su:

**Yamaha** XJ 600 S Diversion/N • TDM 850

XJ 900 S Diversion/N • GTS 1000

Rif. orig.: 4BH-83980-00

**02.78026** interruttore stop dx - alla leva



Adattabile su:

**Honda** CM 200 T (81/82)

CM 400 A/T (79/80) • CB 400 T (79/80)

CX 500 (79/80) • CX 500 Custom (79/80) • CB 650 Custom (79/80)

CB 650 (79/80) • CB 750 K Four (79/80) • CB 750 F Supersport (79/80)

CB 900 Custom (80/81) • CBX 1050 (79/80) • GL 1000 Goldwing (79)

GL 1100 Goldwing (80/81)

Rif. orig.: 35340-422-013

**02.78027** interruttore stop freno/frizione dx/sx - alla leva

Adattabile su:

**Yamaha** Neo's 450 4T (11 - sx) • 125/250 X-Max (05/10 - sx) • 125/250 X-City (05/10 - sx) • Majesty 400/ABS (04/11 - sx)

T-Max 500/ABS (01/10 - sx) • RD 350 LCF (86 - dx) • RD 350 LC (91/92 - dx) • FZR 400 (88/90 - dx) • RD 500 (84 - dx)

FJ 600 (84/85 - dx) • SRX 600 (86/87 - dx) • FZ 600 (86/88 - dx) • FZR 600 (89/93 - dx) • XY 600 Radian (86/89 - dx)

XVS 650 Dragstar (97/02 - dx) • XVS 650 A Dragstar Classic (98/06 - dx) • FZ 750 (86/90 - dx) • FZX 750 (88 - dx) • FZR 750 (87/88 - dx)

XVS 950 A Midnight Star (09/11 - dx) • FZR 1000 (87/88 - dx) • FJ 1100 (84/85 - dx) • XVS 1100 Dragstar (99/02 - dx)

XVS 1100 A Dragstar Classic (00/06 - dx) • FJ 1200 (86/91 - dx) • V-Max 1200 (86/01 - dx) • XVS 1300 A Midnight Star (07/08 - dx)

XVZ 13 TD 1300 (89/90 - dx)

Rif. orig.: J45-82503-01 (36Y-83980-01)



**02.78028** interruttore stop freno/frizione dx/sx - alla levaAdattabile su:

**Yamaha** Neo's 450 4T (11 - sx) • 125/250 X-Max (05/10 - sx) • 125/250 X-City (05/10 - sx)  
 Majesty 400/ABS (04/11 - dx) • T-Max 500/ABS (01/10 - dx) • FZX 750 (88 - sx) • FZ 750 (86/90 - sx)  
 FZR 750 (87/88 - sx) • FZR 1000 (87/88 - sx) • FJ 1100 (84/85 - sx) • FJ 1200 (86/91 - sx) • V-Max 1200 (86/01 - sx)

Rif. orig.: 36Y-82917-00

**02.78029** interruttore stop dx - alla levaAdattabile su:

**Kawasaki** BN 125 Eliminator (00/07) • KLX 125 C/D-Tracker (10/11) • KLX 250 S (09/10) • KLX 250 (93/95)  
 Ninja 250 R (08/10) • ZZR 250 (96/03) • EL Eliminator 250 (96/03) • KVF 360 2X4/4X4 (06/11) • ZXR 400 (90/99)  
 KFX R 450 (08/11) • 500 ER 5 (97/05) • EN 500 Vulcan (92/03) • GPZ 500 S (87/03) • KLE 500 (91/07) • GPX 600 R (88/90)  
 GPZ 600R (87/88) • KLR 600 (91/94) • ZZR 600 (90/06) • ZX-6R 600 (95/01 - 07/10) • ZX-6R 636 (02/06) • ZX-6RR 600 (03/05)  
 KL 650 (87/91) • KLR 650 (95/04) • KLX 650 (93/95) • KLE 650 Versys/ABS (07/10) • 650 ER6-N/F/ABS (06/10) • W 650 (99/05)  
 750 ZX-7R/RR (96/02) • GPX 750 R (87/89) • ZR-7/S 750 (99/03) • Z 750/ABS (04/11) • ZXR 750/R (89/95) • VN 800/Classic/Drifter (98/06)  
 ZX-9R 900 (94/03) • VN 900 Classic/Custom (06/10) • Z 1000/ABS (03/11) • ZX-10R 1000 (04/10) • GTR 1000 (96/03)  
 GPZ 1000 RX (86/88) • ZX-10 1000 Tomcat/Ninja (88/90) • GPZ 1100 (95/97) • ZR 1100 (92/95) • ZRX 1100 (97/99) • ZZR 1100 (90/99)  
 ZRX 1200 (01/04) • ZRX-S 1200 (01/03) • ZRX-R 1200 (01/05) • ZX-12R 1200 (00/06) • ZZR 1200 (02/03) • ZZR 1400 (06/10)  
 GTR 1400 (08/10) • VN 1500/Classic/Drifter/Mean Streak (96/03) • VN 1600/Classic/Drifter/Mean Streak (03/07)

Rif. orig.: 27010-1170 • 27010-0025

**02.78030** interruttore stop dx - alla levaAdattabile su:

**Kawasaki** EN 450 LTD (85/90) • KLR 250 (85/89) • GPZ 305 (83) • Z/KZ 550 Spectre (83)  
 Z/KZ 550F LTD Shaft (83/84) • GPZ 550 (82/86) • KL 600 (84/86) • Z/KZ 750 LTD Shaft (83) • Z/KZ 750 LTD Belt (83)  
 Z/KZ 750 (83) • Z/KZ 750 Spectre (82/83) • GPZ 750 (82/85) • GPZ 750 Turbo (84/85) • VN 750 Vulcan (86/90) • Z/KZ 1000 (81/83)  
 Z/KZ 1000 R Eddie Lawson Replica (82/83) • Z/KZ 1100 Spectre (82/83) • Z/KZ 1100 LTD Shaft (83) • ZN 1100 LTD Shaft (84/85)  
 GPZ 1100 (81/84) • ZN 1300 Voyager (83/86)

Rif. orig.: 27010-1056

**02.78031** interruttore stop sx - alla levaAdattabile su:

**Suzuki** AY 50 Katana (97/06 - disco/disco)  
 UH 125/150 Burgman (02/06) • AN 250 Burgman (99/06)  
 AN 400 Burgman (98/06) • AN 650 Burgman (03)

Rif. orig.: 57560-14F01

**02.7862** interruttore stop - s/cavi - al pedale - Ø 10 MA  
funzionamento a tirare  
contatto normalmente apertoAdattabile su:

**Aprilia** Tuareg 50 Rally • Classic 50/125  
 RX 50 (89/92) • Red Rose 50/125 • STX 125 • AS 125 R  
**Cagiva** SXT 125 • WSXT 125 Aletta Rossa  
 Elefant 125/200 • Elefantre 125 • SST 125 Electra  
 SST 250/350 Ala Verde • SX 250/350 Ala Blu  
 350 Ala Rossa 4T • 350/500 T4 R/E

Rif. Aprilia: AP8112086 (8112270/8112044)



Sostituisce art. 02.7857

**02.7892** microinterruttore stop alla leva c/innesto molex femmina - cavo mm. 730Di primo equipaggiamento su:

**Aprilia** Classic 50 • MX 50 (02/04) • RX 50 (95/05) • RX 50 Racing (03/06) • RS 50 (96/05)  
 RS 50 Tuono (03/05) • AF1 125 Sintesi/Replica • Red Rose 125 • Tuareg 125/Wind/Rally  
 RX 125 • Pegaso 125 • Tuareg 350/600 Wind • Pegaso 600/650 (90/95)

Adattabile su:

**Aprilia** AF1 125/Europa • ETX 350 • Tuareg 350  
**Moto Guzzi** NTX 350/650 • Nevada 350 (92/93) • 350 V35 Carabinieri/PA (92/01) • 350 V35 III (85/87) • V50 P.A. (92/01)  
 650 V65 Florida • 650 V65 Polizia/P.A. (88/95) • 750 SP • 750 X Polizia (92/94) • Nevada 750 (91/93) • Strada 750 • Targa 750  
 750 V75 PA (92/96) • 1000 GT • 1000 S • 1000 SP III • California 1000 Carb./IE/Carenato (87/93) • Le Mans 1000 (84/93) • Strada 1000 (93/94)

Rif. Aprilia: AP8212196 • AP8112358

Rif. Guzzi: GU27749815 (66741115)



## Interruttori idraulici stop

02.7793 Ø 10 - passo 1,5

Adattabile su:

**Piaggio** Ape 250 • Ape MP 500/550/600 • Ape P 501/601 • Ape Car • Ape P 50 (estero) • Ape Car P2/P3 (78/85)

Rif. orig.: 104412



## Bulbi pressione olio

02.7859 bulbo pressione olio (pressostato) - Ø 12x1,5

Adattabile su:

**Moto Guzzi** 350 V35/II • 500 V50/III/Polizia • V7 700 • V7 750 Sport • V7 750 Ambassador • 750 S/S3  
850 Le Mans I/II/III • 850 T3 California • V7 850 Eldorado • 850 T3/T4/T5/Civile/Polizia/PA • 1000 GT  
1000 S • 1000 SP/II/III • 1000 V10 • 1000 Quota • 1000 Strada • 1000 Le Mans • 1000 Daytona/Racing  
1000 California/II/III/Carb./IE • 1100 Quota • 1100 Sport • 1100 V11 Sport  
1100 California (94/08 - tutti) • 1100 V11 Le Mans/Sport/Naked/Café

Rif. orig.: GU17768750 (12768700)

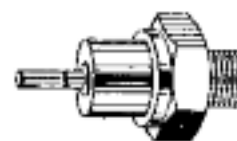

02.7891 bulbo pressione olio (pressostato) - Ø 12x1,5

Di primo equipaggiamento su:

**Moto Guzzi** Nevada 350/Club (92/99) • 350 V35 II/III • 500 V50 P.A.  
650 V65 Polizia/P.A. (88/95) • 650 V65 Custom/Florida • 650 V65 SP/Lario  
750 Nevada (91/97) • 750 SP • Strada 750 • Targa 750 • 750 V75 P.A. (92/01)  
750 X Polizia (92/94)

Rif. orig.: GU19768720

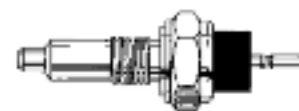

## Attacchi candela

02.75167 forcella candela in ottone  
c/cavo Ø 60 cm. - Ø 7



Adattabile su:

**Piaggio** Vespa - ciclomotori c/volano magnete

Rif. orig.: 080341 cavo • 127966 attacco

Sostituisce 02.7516.

02.7502 per cavo candela Ø 7  
02.7522 per cavo candela Ø 5  
tipo economico in bachelite  
attacco filetto Ø 4 - s/antidisturbo



Adattabile su:  
ciclomotori vari

02.7505 in neoprene - c/fascetta - nero  
attacco niples SAE 6,2  
s/antidisturbo



Adattabile su:  
applicazioni varie • cross

02.7513 per cavo candela Ø 7  
in gomma c/molla  
02.75131 per cavo candela Ø 5  
in gomma c/molla



Adattabile su:

applicazioni varie • agricolo • motoseghe

02.7517 in bachelite - s/antidisturbo - attacco niples SAE 6,2  
02.75177 in bachelite - s/antidisturbo - attacco niples SAE 6,2 - adattabile



Di primo equipaggiamento su:

**Gilera** Easy Moving 50 • DNA 50/GP Exp. • Runner 50 (97/00)  
Storm 50 (94/95) • Typhoon 50/X/XR (94/00)  
Runner 125/180 FX/FXR (97/01)

**Innocenti** Lambretta LI/DL • Lambro

**Piaggio** Boss 50 • Bravo 50/3 • Ciao/PX/FL/Mix/Euro 1/2 • Free 50/FL/Delivery • Grillo 50  
Liberty 50 2T (97/05) • NRG 50/Extreme/MC<sup>2</sup> • Quartz 50 • Sfera 50/Maq 2/RST  
Si/FL2/Mix • Superbravo/3 • Typhoon 50 (01/04) • Zip 50 Base/RST/Fast Rider/RST (92/99)  
Zip 50 SP (96/00) • Hexagon LX4 125 • Hexagon 125/180 LX/LXT

Rif. Piaggio/Gilera: 103936

Rif. Innocenti: 15017070

**02.75257** in metallo - c/antidisturbo 5K Ω - attacco filetto Ø 4



Adattabile su:

**Cagiva • Ducati • Moto Guzzi • Piaggio Vespa Ape • Moto varie**

Rif. Guzzi: GU147174

Rif. Piaggio: 029465

Rif. Ducati/Cagiva: 002288871 • 000026548 • 800026548 • 097746525

Sostituisce 02.75255.

**02.7527** speciale in gomma nera  
attacco nipples SAE 6,2  
s/antidisturbo



Adattabile su:

**motori marini • cross • vari**

**02.7528** per cavo candela Ø 5  
speciale in gomma nera

**02.75281** per cavo candela Ø 7  
speciale in gomma nera



Adattabile su:

**cross e vari**

Di primo equipaggiamento su:

**Minarelli e vari • Applicazioni agricole**

**02.7537** super speciale in gomma rossa  
in silicone - attacco filetto Ø 4  
s/antidisturbo



Adattabile su:

**applicazioni varie • cross • motori Marini**

**02.7585** s/antidisturbo attacco filetto Ø 4  
angolo 120°



Adattabile su:

**moto Honda • Kawasaki**

**02.75861** c/antidisturbo 5K Ω  
angolo 102° - tipo interno  
attacco filetto Ø 4



Adattabile su:

**moto Honda • Kawasaki  
Suzuki • Yamaha**

Equivalente NGK XD05F • XB05F

**02.75867** c/antidisturbo 5K Ω  
angolo 90° - tipo interno  
attacco filetto Ø 4



Adattabile su:

**moto Honda • Kawasaki  
Suzuki • Yamaha**

**02.75871** c/antidisturbo 5K Ω  
angolo 120° - tipo esterno  
attacco filetto Ø 4



Adattabile su:

**moto Honda • Suzuki**

Equivalente NGK VD05F • VB05F

**02.75881** c/antidisturbo 5K Ω - attacco filetto Ø 4



Adattabile su:

**moto Honda • Kawasaki • Yamaha**

Equivalente NGK SD05F • SB05F

**02.75891** c/antidisturbo 5K Ω - angolo 90° - attacco filetto Ø 4



Adattabile su:

**moto Honda • Kawasaki  
Suzuki • Yamaha**

**02.75911** c/antidisturbo 5K Ω  
angolo 90° - attacco filetto Ø 4

**02.75917** c/antidisturbo 5K Ω  
angolo 90° - attacco filetto Ø 4



Adattabile su:

**Honda scooter 50 e moto varie  
moto Kawasaki • Kymco scooter 50/100  
Peugeot scooter 50/100 • moto Suzuki • moto Yamaha**

Equivalente NGK LD05F • LB05F

**02.75927** c/antidisturbo 5K Ω - angolo 90°  
attacco nipples SAE 6,2



Adattabile su:

**scooter • maxiscooter • moto varie**

Equivalente NGK LB05EZ

**02.7593** termoindurente c/antidisturbo 5K Ω - attacco filetto Ø 4Di primo equipaggiamento su:motori **Minarelli/Yamaha** 50 acqua**Minarelli** 50 AM6 (Power-Up)motori **Franco Morini** 50 acqua/400 4Tmotori **Aprilia** Ditech 50 acqua • SR 50 Ditech • SR 50 H<sub>2</sub>O (00/>)**Benelli** 50 491 RR/ST Morini (03/>) • 491 RR (99/01)

50 Naked Morini (03/&gt;) • 491 Racing (98/99)

50 K2 LC (98/01) • Velvet 400

**Malaguti** CNK 50 Drakon • 50 XTM/XSM/Power-up

50 F12 LC/LC RST/LC Euro 1/2/2.3 (94/06) • 50 F12 R AC/LC (07/10)

F10 AC (08/10) • 50 F15 Firefox LC/RST/Euro 1/2/2.3 (96/07)

**MBK** Nitro 50/Euro 2 (97/07)**Suzuki** Katana 50 LC (97/04) • Katana 50 I.E. (05/>) • Zillion 50**Yamaha** Aerox 50/R/L Euro 2 (97/07) • DT 50 R/SM/X (03/10)Adattabile su:**ciclomotori e motocicli vari**Rif. **Aprilia**: AP2REA000111 • AP8224379Rif. **Benelli**: R290077138000 • R013433004000

R51740011A0

Rif. **Malaguti**: 07300700Rif. **MBK/Yamaha**: 5BR-H2370-00 • 5PE-H2370-00 • 104-H2371-00Rif. **Suzuki**: 33510-02E20 • 33510-02E00**02.7594** termoindurente c/antidisturbo 5K Ω - attacco filetto Ø 4Di primo equipaggiamento su:motori **Minarelli/Yamaha** 50 aria/acqua**Aprilia** Amico 50 • Area 51 • Gulliver 50/LC • Scarabeo 50 2T (93/05)

SR 50 Air/LC/WWW/Stealth/Netscaper/Racing/Sport (93/01) • Sonic 50/LC/GP • Rally 50 Air/LC

**Benelli** 50 491 GT/SP/Sport/ST (98/01) • K2 50 Air (98/>) • Naked 50 (02) • Pepe 50/LX/Old (99/07)**Malaguti** Centro 50 Base/SL/Cat. • Ciak 50 2T/Mono/Master/Euro 2/2.3 (99/06)

50 F10/RST/Euro 1/2/2.3 (99/06) • 50 F12/RST/Euro 1/2/2.3 (94/06) • 50 F15 Air • 50 Yesterday

**MBK** Booster 50 Spirit/Euro 2 (96/03) • Booster 50 (01/02) • Booster 50 L (01/03) • Booster 50 NG/Euro 1 (95/03)

Booster 50 Rocket/Track • 50 Mach-G Euro 1/2 (02/04) • 50 Stunt • 50 Forte • 50 Flipper/Cat. (98/00) • 50 Ovetto/Euro 1/2 (97/04)

**Yamaha** BW'S 50 Next Generation/Cat. (97/06) • BW'S 50 Original/Euro 2 (97/03) • BW'S 50 R (01) • BW'S 50 L (03)

Jog 50 R/Euro 2 (02/07) • CW'S 50 Spy • Slider 50 • Axis 50 • 50 Why/Euro 1 (98/00) • 50 Neo's/Euro 2 (97/06)

Rif. **Aprilia**: AP8220438/439/440Rif. **Benelli**: R51740021A0Rif. **Malaguti**: 07300600Rif. **MBK/Yamaha**: 3WG-H2370-10**02.7595** termoindurente c/antidisturbo 5K Ω - attacco filetto Ø 4Di primo equipaggiamento su:motori **Franco Morini** 50 aria/100**Aprilia** Habana 50/Custom • Mojito 50 (99/03)**Italjet** Formula 50 • Torpedo 50 2T • Velocifero 50**Malaguti** 50 Crosser CR1 • Ciak 100 • F 12 100**Rizzato** scooter 50 motori **Franco Morini****Suzuki** AP 50 • Address 50/100 • AJ Sepia 50/ZZ

Katana 50 Air • Estilete 50 • Street Magic 50 • 110 Hokuto

Rif. **Aprilia**: AP3REA000035/36Rif. **Malaguti**: 07300800 • 61413900Rif. **Suzuki**: 33510-02E10 • 33510-35411**02.7596** termoindurente c/antidisturbo 5K Ω  
attacco nipples SAE 6,2Di primo equipaggiamento su:motore **Aprilia** Ditech 50 aria

Scarabeo 50 Ditech

Rif. orig.: AP8224399

**02.7597** termoindurente c/antidisturbo 5K Ω - attacco nipples SAE 6,2Di primo equipaggiamento su:motori **Yamaha/Minarelli** 100 2T aria**Aprilia** Scarabeo 100 2t**Benelli** K2 100**MBK/Yamaha** Booster/BW'S 100

Nitro/Aerox 100 • Ovetto/Neo's 100

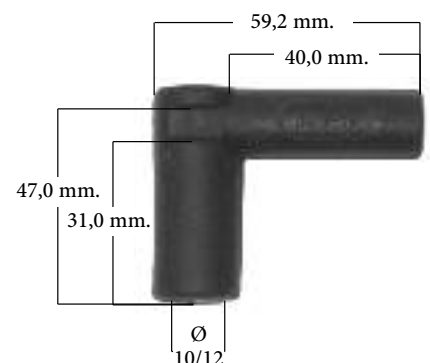
Adattabile su:motori **Piaggio** scooter 50 2tRif. **Aprilia**: AP8510734/735 • AP8220601Rif. **Benelli**: R51740031ARif. **MBK/Yamaha**: 4VP-H2370-00**02.7598** in silicone nero impermeabile  
c/antidisturbo 5K Ω - attacco nipples  
SAE 6,2 - per candela c/ceramica Ø 10**02.75982** in silicone nero impermeabile  
c/antidisturbo 5K Ω - attacco nipples  
SAE 6,2 - per candela c/ceramica Ø 12**02.75981** in silicone nero impermeabile  
c/antidisturbo 5K Ω - attacco filetto Ø 4  
per candela c/ceramica Ø 10**02.75983** in silicone nero impermeabile  
c/antidisturbo 5K Ω - attacco filetto Ø 4  
per candela c/ceramica Ø 12Adattabile su:

moto e ciclomotori da strada e fuoristrada, scooter

**Aprilia • Beta • Cagiva • Derbi • Gilera • KTM • Husqvarna • Ducati • Moto Guzzi • Piaggio**

## Gruppi cavi impianti elettrici completi "Piaggio Vespa"



cc	Modello	anno	Telaio	Caratteristiche veicolo	cod. SGR	Rif. originale
<b>VESPA</b>						
50	Vespa 50/N	63/66	V5A1 fino a 122877 - Italia	s/luce stop - lamp. ant. monoluce	<b>18.9764 ▲</b>	70462/102462
50	Vespa 50/N	66/71	V5A1 da 122878 - Italia	s/luce stop - lamp. ant. monoluce	<b>18.9764</b>	102462
50	Vespa 50 L	66/70	V5A1 da 500001 - Italia	s/luce stop - lamp. ant. monoluce	<b>18.9764</b>	102462
50	Vespa 50 R	69/80	V5A1 da 700001 a 922850	s/batteria - s/frecce	<b>18.9764</b>	102462
50	Vespa 50 R	69/80	V5A1 da 800001 a 860260 - Francia	s/batteria - s/frecce	<b>18.9803</b>	142965
50	Vespa 50 Special	72/75	V5B1	s/batteria - s/frecce	<b>18.9803</b>	142965
50	Vespa 50 Special	75/80	V5B3 fino a 310809	s/batteria - s/frecce	<b>18.9803</b>	142965
50	Vespa 50 Special Revival	91	V5R1	s/batteria - s/frecce	<b>18.9803</b>	142965
90	Vespa 90	63/84	V9A1	s/batteria - s/frecce	<b>18.9784 ◆</b>	71283/151390/159656
90	Vespa 90 SS Super Sprint	65/71	V9SS1	s/batteria - s/frecce	<b>18.9784 ◆</b>	151390/159656
100	Vespa 100	78/84	V9B1	s/batteria - s/frecce	<b>18.9784 ◆</b>	151390/159656
125	Vespa 125	48/50	V1/V15	s/luce posizione	<b>18.9705</b>	018201
125	Vespa 125	50/52	V30/V33	s/luce posizione	<b>18.9705</b>	018201
125	Vespa 125	51/52	V30/V33	c/luce posizione	<b>18.9710</b>	022681
125	Vespa 125 U (Utilitaria)	53	VU1	s/luce posizione	<b>18.9705</b>	018201
125	Vespa 125	52/53	VM1	s/luce posizione	<b>18.9705</b>	018201
125	Vespa 125	53/54	VM2	c/luce posizione	<b>18.9710</b>	022681
125	Vespa 125	54/55	VN1	s/batteria	<b>18.9710</b>	022681
125	Vespa 125	56/57	VN2	s/batteria	<b>18.9710</b>	022681
125	Vespa 125	57	VNA1	s/batteria	<b>18.9714</b>	081021
125	Vespa 125	58/59	VNA2	s/batteria	<b>18.9714</b>	081021
125	Vespa 125	59/61	VNB1	c/batteria	<b>18.9751</b>	087212
125	Vespa 125	61/64	VNB2/VNB5	s/batteria	<b>18.9785</b>	55071/093489
125	Vespa 125	65/66	VNB6	s/batteria	<b>18.9783</b>	090376
125	Vespa 125 (Nuova)	65/67	VMA1	s/batteria - s/frecce	<b>18.9765 ◆</b>	144505
125	Vespa 125 Primavera	67/83	VMA2	s/batteria - s/frecce	<b>18.9784 ◆</b>	151390/159656
125	Vespa 125 Primavera ET3	76/83	VMB1	s/batteria - s/frecce	<b>18.9800</b>	149247
125	Vespa 125 GT	66/73	VNL2 da 30001	s/batteria - s/frecce	<b>18.9783</b>	91462/158987
125	Vespa 125 GTR	68/77	VNL2 da 100001 a 145900	s/batteria - s/frecce	<b>18.9782</b>	144032/114309
125	Vespa 125 Sprint/GT	65/73	VNL2 - Estero	s/batteria - s/frecce	<b>18.9783</b>	91462/158987
125	Vespa 125 Super	65/69	VNC1	s/batteria	<b>18.9783</b>	91462/158987
150	Vespa 150	55	VL1	s/batteria	<b>18.9710</b>	022681
150	Vespa 150	55	VL1	c/batteria	<b>18.9752</b>	081300
150	Vespa 150	56/57	VL3	c/batteria	<b>18.9752</b>	081300
150	Vespa 150	57/58	VB1 - Italia	c/batteria - s/luce stop	<b>18.9752</b>	081300
150	Vespa 150	58/59	VBA fino a 76050	c/batteria	<b>18.9756</b>	084354
150	Vespa 150	59/60	VBA da 76051	c/batteria	<b>18.9757</b>	084354001
150	Vespa 150	60/61	VBB1 fino a 71000 - Italia	c/batteria	<b>18.9753</b>	086444

▲ per essere montato su veicoli V5A1 precedenti al 122877 togliere le 5 prese di contatto poste all'estremità dei cavetti di collegamento dei fari anteriori e posteriori

◆ per i veicoli privi di luce contakm. isolare il cavetto elettrico non utilizzato con un nastro isolante

cc	Modello	anno	Telaio	Caratteristiche veicolo	cod. SGR	Rif. originale
150	Vespa 150	61/62	VBB1 da 71001 a 146000 - Italia	c/batteria	<b>18.9754</b>	057126
150	Vespa 150	62/67	VBB2 da 146001 - Italia	s/batteria	<b>18.9762</b>	092653
150	Vespa GL	57/58	VGL1 - <u>Estero</u>	c/batteria	<b>18.9752</b>	081300
150	Vespa GL	62/65	VLA1 - Italia	c/batteria	<b>18.9720</b>	070651
150	Vespa GL	62/65	VLA1 - <u>Estero</u>	s/batteria	<b>18.9762</b>	092653
150	Vespa 150 Super	65/79	VBC1	s/batteria - s/frecce	<b>18.9783</b>	91462/158987/144034
150	Vespa Sprint (1.ma serie)	65	VLB1 fino a 025400	s/batteria	<b>18.9786</b>	090388
150	Vespa Sprint (2.nda serie)	65/74	VLB1 da 025401	s/batteria	<b>18.9783</b>	91462/158987
150	Vespa Sprint Veloce	69/77	VLB1 da 0150001 a 0294259	s/batteria - s/frecce	<b>18.9782</b>	144032/114309
150	Vespa 150 GS	57	VS3 da 0023301 a 0035300	c/batteria	<b>18.9712</b>	081216
150	Vespa 150 GS	58	VS4 da 0035301 a 0041715	c/batteria	<b>18.9712</b>	081216
150	Vespa 150 GS	58	VS4 da 0041716 a 0047310	c/batteria	<b>18.9713</b>	084612
150	Vespa 150 GS	59/61	VS5 da 0047350 a 0060122	c/batteria	<b>18.9713</b>	084612
160	Vespa 160 GS 1.ma serie	62/63	VSB1 da 001001 a 0036000	c/batteria	<b>18.9716</b>	093736
160	Vespa 160 GS 2.nda serie	63/64	VSB1 da 0036001 a 0061000	c/batteria	<b>18.9717</b>	070124
160	Vespa 160 GS	62/64	VSB1	s/batteria	<b>18.9762</b>	70193/99345/092653
180	Vespa 180 SS	64/65	VSC1 fino a 0018000	c/batteria	<b>18.9828</b>	73726/092653001
180	Vespa 180 SS	65/68	VSC1 da 0018001	c/batteria	<b>18.9828</b>	150433/092653001
180	Vespa 180 SS	64/68	VSC1	s/batteria	<b>18.9762</b>	99345/092653
180	Vespa 180 Rally	68/73	VSD1	s/batteria	<b>18.9782</b>	114309
200	Vespa 200 Rally	74/79	VSE1T	s/batteria - c/chieve	<b>18.9829</b>	146110

## VESPA PX

125	Vespa P 125 X	77/82	VNX1	s/frecce - s/batteria	<b>18.9801</b>	162064/182312
125	Vespa P 125 X	77/82	VNX1	c/frecce - s/batteria	<b>18.9807</b>	181940/242734
125	Vespa PX 125 E	81/83	VNX2 fino a 200000	c/frecce - s/batteria	<b>18.9808</b>	182310/243566
125	Vespa PX 125 E Arcobaleno	83/97	VNX2 da 200001	c/frecce - s/batteria s/avviamento elettrico	<b>18.9826</b>	217897
125	Vespa PX 125 E Arcobaleno	83/97	VNX2 da 200001 - <u>Austria</u>	c/frecce - s/batteria	<b>18.9826</b>	21789
125	Vespa PX/Euro 2	98/07	VNX2 da 06000001/M09302	freno a disco c/avviamento elettrico	<b>18.9827</b>	580347
125	Vespa PX 30 Anni	07/08	M09302	freno a disco c/avviamento elettrico	<b>18.9827</b>	580347
125	Vespa PX	11	M74100	freno a disco c/avviamento elettrico	<b>18.9827</b>	580347
150	Vespa P 150 S	78/84	VBX1	s/frecce - s/batteria	<b>18.9801</b>	162064/182312
150	Vespa P 150 S	78/84	VBX1	c/frecce - s/batteria	<b>18.9807</b>	182311/242734
150	Vespa P 150 X	78/81	VLX1 fino a 346402	s/frecce - s/batteria	<b>18.9801</b>	162064/182312
150	Vespa P 150 X	78/81	VLX1 fino a 346402	c/frecce - s/batteria	<b>18.9807</b>	181940/242734
150	Vespa PX 150 E	81/83	VLX1 da 346403 a 600000	c/frecce - s/batteria	<b>18.9808</b>	182310/243566
150	Vespa PX 150 E Arcobaleno	83/97	VLX1 da 600001	c/frecce - s/batteria s/avviamento elettrico	<b>18.9826</b>	217897
150	Vespa PX	98/01	VLX1 da 06000001	freno a disco c/avviamento elettrico	<b>18.9827</b>	580347
150	Vespa PX	11	M74200	freno a disco c/avviamento elettrico	<b>18.9827</b>	580347
200	Vespa P 200 X	77	VSX1 da 100 a 1700	s/frecce - s/batteria	<b>18.9801</b>	162064/182312
200	Vespa P 200 E	77/82	VSX1 fino a 160000	c/frecce - s/batteria	<b>18.9808</b>	163191/182310/243566
200	Vespa PX 200 E	82/83	VSX1 fino a 160000 a 300000	c/frecce - s/batteria	<b>18.9808</b>	182310/243566
200	Vespa PX 200 E Arcobaleno	83/97	VSX1 da 300001	c/frecce - s/batteria s/avviamento elettrico	<b>18.9826</b>	217897
200	Vespa PX	98/01	VSX1 da 06000001	freno a disco c/avviamento elettrico	<b>18.9827</b>	580347



## Resistenze

**02.8001** resistenza 5W - 10,2 Ohm

Di primo equipaggiamento su:

**Kymco** 250 Gran Dink/Bet & Win/People/Yup • 125 Dink Euro 3 (06/10) • 250 People S (06 - carb.)

Adattabile su:

**scooter vari**

Rif. Kymco: 00169731 • 35400-KHE7-E00



## Prese di corrente

**02.7558** presa bassa tensione



Adattabile su:

**Piaggio** Vespa 125 GT/GTR • Vespa 125/150 Super • 150 Sprint  
Vespa 150 Sprint veloce • Vespa 180/200 Rally

Rif. orig.: 120811 (070403)

**02.7565** presa bassa tensione



Adattabile su:

**Piaggio** Vespa 50 Special • Vespa 50 S • Vespa 50 Sprinter  
Vespa 50 Super Sprint • Vespa 90/Racer/Super Sprint  
Vespa 125 Primavera (67/>) • Vespa 125 ET3 • Ape 50 TL1/TL2

Rif. orig.: 0707445 (070744)

## Cavi e cavetti

Cavetto Viplax FR/2 - nero  
Matasse da 100 metri

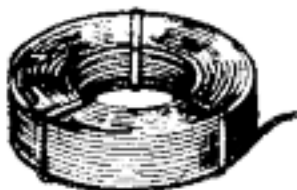

Codice

**18.9653** Ø 0,50 mm.  
**18.9654** Ø 0,78 mm.  
**18.9655** Ø 1,00 mm.  
**18.9656** Ø 1,50 mm.

Guaina nera per cavi  
Matasse da 50 metri

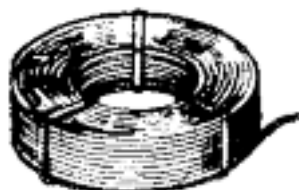

Codice

**18.9577** Ø 3,00 mm.  
**18.9578** Ø 4,00 mm.  
**18.9585** Ø 7,00 mm.  
**18.9581** Ø 10,00 mm.

**18.9672** cavo candela nero - Ø 7  
matasse da 100 metri

**18.9674** cavo candela nero - Ø 5  
matasse da 100 metri



## Connettori

**02.59557** connettore rettangolare femmina  
c/asola - 8 faston maschi medi



**02.58323** connettore rettangolare maschio  
c/asola - 8 faston femmina medi



**02.58442** connettore rettangolare femmina  
c/asola - 6 faston maschi medi



**02.57648** connettore rettangolare femmina  
c/linguetta - 6 faston maschi medi



**02.57649** connettore rettangolare maschio  
c/asola - 6 faston femmina medi



**02.58718** connettore rotondo femmina  
6 faston maschi tondi



**02.57145** connettore rettangolare maschio  
c/asola - 6 faston femmina mini



**02.56831** connettore rettangolare femmina  
c/linguetta - 6 faston maschi mini



**02.59518** connettore rotondo femmina  
c/asola - 5 faston maschi medi



**02.57980** connettore rettangolare maschio  
c/asola - 4 faston femmina medi



**02.58333** connettore rettangolare femmina  
c/linguetta - 4 faston maschi medi



**02.58674** connettore rettangolare femmina  
c/asola - 4 faston maschi medi



**02.58647** connettore rettangolare femmina  
c/asola - 4 faston maschi medi



**02.57147** connettore rettangolare femmina  
4 faston maschi medi



**02.57650** connettore rettangolare femmina  
c/linguetta - 3 faston maschi medi



**02.56839** connettore rettangolare maschio  
c/asola - 3 faston femmina medi



**02.58357** connettore rettangolare femmina  
c/asola - 3 faston maschi medi



**02.59521** connettore rettangolare femmina  
c/asola - 3 faston maschi grandi verticali



**02.57146** connettore rettangolare femmina  
3 faston maschi medi



**02.58707** connettore rotondo femmina  
3 faston maschi medi



**02.58001** connettore rettangolare maschio  
c/asola - 2 faston femmina medi



**02.59555** connettore rettangolare femmina c/linguetta  
2 faston maschi medi



**02.59556** connettore rettangolare femmina c/linguetta  
2 faston maschi grandi



## Capocorda

**02.9851** Ø 4  
**02.9857** Ø 8 • per batteria



**02.9858** Ø 5  
**02.9859** Ø 6



sostituiscono 02.9852 e 02.9853

**02.9860** Ø 6 • a forchetta



**02.9849** maschio • speciale a spina  
**02.9848** femmina • speciale a spina



**02.9862** maschio tipo fiat  
**02.98621** femmina tipo fiat



**02.9873** maschio • faston mini



**02.9885** maschio • faston piccolo



**02.9868** maschio • faston medio



**02.9847** maschio medio • tipo lungo



**02.9870** femmina • faston mini



**02.9850** femmina • faston piccolo



**02.9867** femmina • faston medio  
**02.9846** femmina medio • c/dente ritegno



**02.9883** femmina medio • attacco laterale



**02.9887** femmina • faston grande



**02.9880** protezione faston femmina medio  
 (per 02.9867)



**02.9884** protezione faston femmina piccolo  
 (per 02.9850)



**02.9886** protezione faston femmina mini  
 (per 02.9870)



## Fusibili in vetro

Codice	Lungh.	Amp.
<b>60.2080</b>	25 mm	7 amp.
<b>60.2081</b>	25 mm	10 amp.
<b>60.2082</b>	25 mm	15 amp.
<b>60.2083</b>	25 mm	20 amp.
<b>60.2088</b>	30 mm	15 amp.
<b>60.2087</b>	32 mm	10 amp.

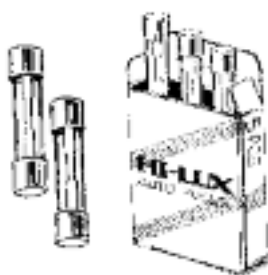

## Fusibili normali

Codice	Lungh.	Amp.
<b>02.9600</b>	25 mm	8 amp.
<b>60.2072</b>	25 mm	16 amp.
<b>60.2073</b>	25 mm	25 amp.
<b>60.2075</b>	25 mm	40 amp.

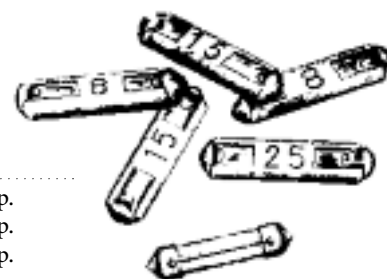

## Fusibili a lama - tipo normale "Fuse Blade"

Codice SGR	Amp.	Colore
<b>60.2091</b>	5	beige
<b>60.2092</b>	7,5	marrone
<b>60.2093</b>	10	rosso
<b>60.2094</b>	15	blu chiaro
<b>60.2095</b>	20	giallo
<b>60.2096</b>	25	trasparente
<b>60.2097</b>	30	verde
<b>60.2098</b>	40	arancio

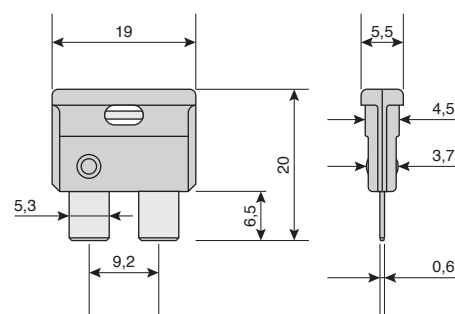

## Fusibili a lama - tipo piccolo "Mini Blade"

Codice SGR	Amp.	Colore
60.3000	5	beige
60.3001	7,5	marrone
60.3002	10	rosso
60.3003	15	blu
60.3004	20	giallo
60.3005	30	verde

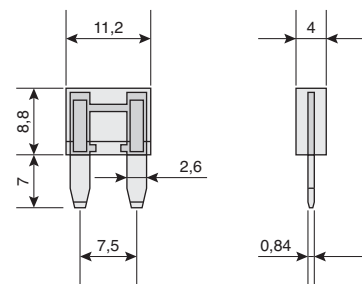

## Spie luci

02.61721 spia luce verde c/portalampada



Adattabile su:

**Piaggio** Vespa 50 Elestart (69/76)  
125 TS VNL3 (75/78) • 125 GTR VNL2 (69/78)  
150 Sprint Veloce VLB1 (69/79) • 180 Rally VSD1 (68/73)  
200 Rally VSE1 (72/79)  
Rif. orig.: 146172

02.61722 spia luce rossa c/portalampada



Adattabile su:

**Piaggio** Vespa 50 Elestart (69/76)  
125 TS VNL3 (75/78) • 125 GTR VNL2 (69/78)  
150 Sprint Veloce VLB1 (69/79)  
180 Rally VSD1 (68/73) • 200 Rally VSE1 (72/79)  
Rif. orig.: 146172

## Articoli vari

15.9881 nastro isolante nero lucido 10x15  
confezione da 10 pezzi



60.2100 portafusibili a lama



Adattabile su:

**Piaggio** Cosa CL/CLX 125/150/200/Cosa 2  
**Applicazioni varie**  
Rif. Piaggio: 253371

## Pompe "Mitsuba"

60.5005\*\* pompa elettronica "Mitsuba" per carburante impianto 12V  
installabile su ogni tipo di veicolo compresi piccoli aerei,  
natanti e centraline di riscaldamento

60.5006\*\* filtro di ricambio

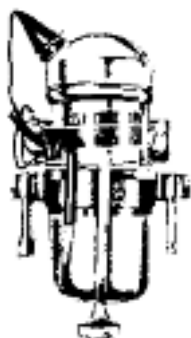

80.605009\*\* pompa tergicristallo "Mitsuba" s/fascetta - 12V

